

The background of the page is a detailed cross-section of a wall assembly. From left to right, it shows a white textured surface, a blue mesh reinforcement, a grey insulation layer, a dark grey metal stud, a brown acoustic insulation layer, a dark grey metal stud, a light blue vertical channel, and a grey concrete block. The assembly is shown in a corner configuration.

WM111C.1

Single Stud



Pebble dash



Combing technique



WM111C.1

Single stud

With a profile of only 142.5 mm and an installation time of 82 min/m², the WM111C.1 system is a straightforward solution for buildings with no remarkably challenging requirements for sound and thermal insulation and for regions with low seasonal differences in temperature and humidity. It consists of a single metal stud frame planked with AQUAPANEL® Cement Board Outdoor on the outside and with a double layer of gypsum boards on the inside. For rooms with special priorities such as water resistance, acoustic control or fire resistance, those interior boards can easily be replaced by high-performance boards from Knauf's versatile range of wall linings.



Modelling render



Sandstein design



CONTENTS

Axonometry	4
Static features and physical properties	5
Economic advantages	6
Construction drawings	10
Sample specifications	19
Product range	28
Product handling and installation	39
Material consumption and erection time	52

Axonometry

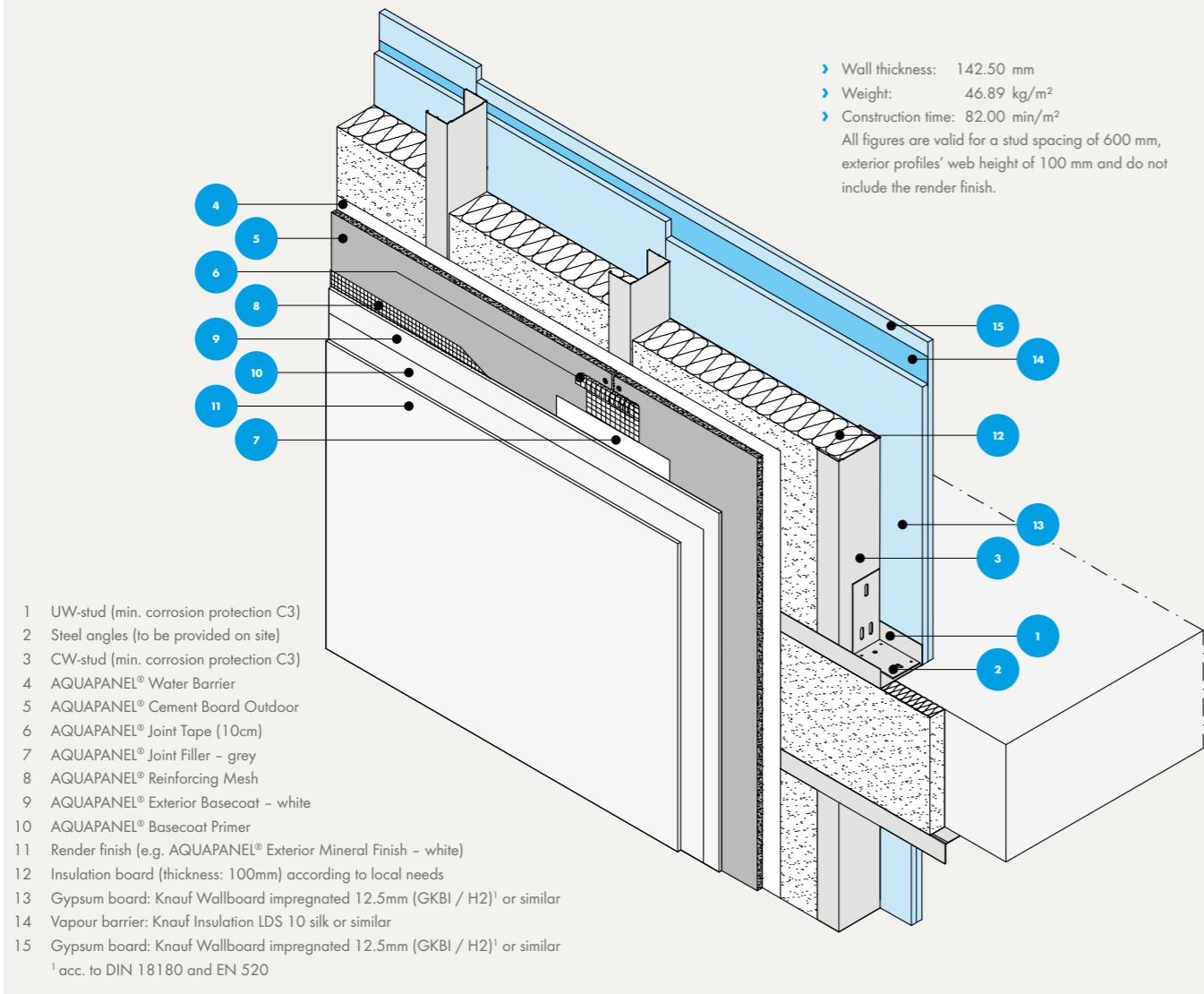

Characteristics of the construction

- ▶ Especially economical.
- ▶ Extremely slim and lightweight design.
- ▶ No special requirements for constructional thermal insulation: Non-residential buildings (target room temperature ≥12°C), e. g. warehouses, parking garages or balcony railings.

Particularities for the assembly

- ▶ An appropriate corrosion protection is to be considered, at least C3 according to EN ISO 12944.
- ▶ The vertical studs have to be fixed to the load-bearing structure using appropriate angels, fasteners and anchoring materials.
- ▶ Where appropriate use thermal decoupling between the board-cladding and the vertical metal stud.
- ▶ Use a thermal decoupling below the UW runner.

Preliminary design acc. to EN 1993-1-3 for CW 150/50/06

Wind load w_e (kN/m ²)	span (m); wall heights								
	2.4	2.6	2.8	3.0	3.2	3.4	3.6	3.8	4.0
0.4									
0.5									
0.6									
0.7									
0.8									
0.9									
1.0									
1.1									
1.2									
1.3									
1.4									
1.5									
1.6									
1.7									
1.8									
1.9									
2.0									
2.1									
2.2									
2.3									
2.4									
2.5									
2.6									
2.7									

Span table is used to show how the substructure needs to be dimensioned as a function of wind loads [kN/m²] according to national standards and the span widths of the profiles, which are determined (usually synonymous with floor height).

The substructure shown in the table comprises only the CW-stud 150/50/06. The fixing to the load-bearing structure is not considered. It is assumed, that the profile is planked with a suitable board both sides (AQUAPANEL® Cement Board Outdoor on the exteriors and a gypsum based board on the interiors). An angle fixation of the profile to connect to the load-bearing structure is recommended in any case.

Please note: the table provides an indication for preliminary design purposes only. This must be subsequently verified by an object-related structural calculation, following the relevant local norms and guidelines. The choice of anchors and further fixing materials (e.g. angle fixation) to transfer the loads into the primary structure should only be made on the basis of this project-specific structural design.

Further profile solutions can be demonstrated by a simple proof of the fitness for use shown by a deformation limit of max. $f = l/300$.

- 600 mm stud spacing
- 400 mm stud spacing
- On request
- Back to back or boxed





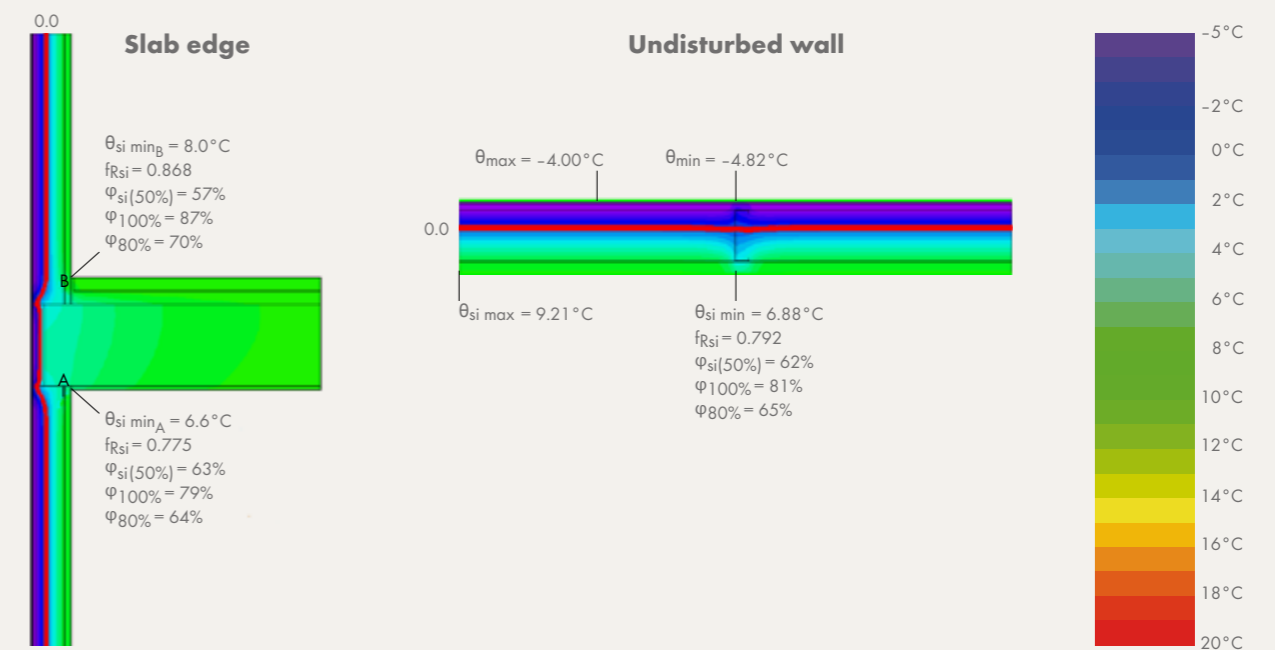

Building-physical features

Heat transition coefficient* $U_w = U_0 + U_{WB, Profile}$ (undisturbed wall, metal profiles are taken into account) - [W/m ² K]	0.486
Thermal bridge heat transfer at slab edge (linear thermal transmittance) Psi-value/ Ψ -value - [W/mK]	0.437
Sound reduction index R_w^* - [dB]	54**
Fire performance (i ↔ o)	EI30

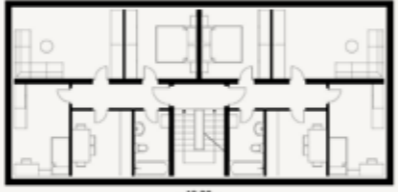
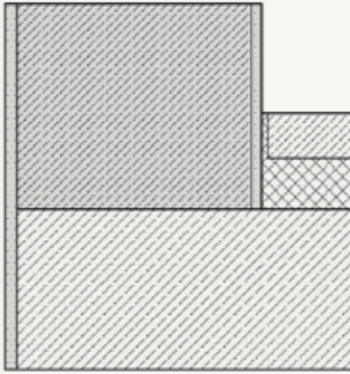
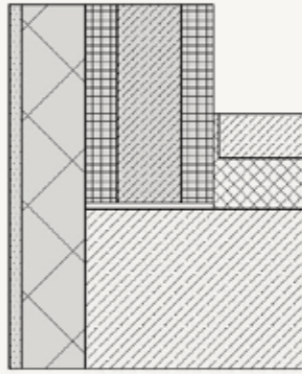
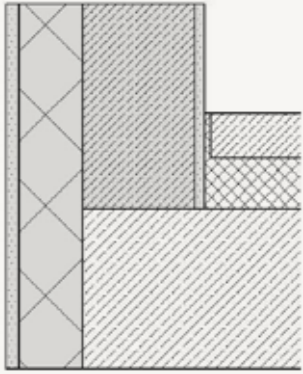
Temperature fields and isotherms*

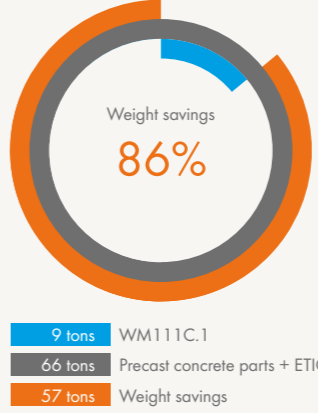
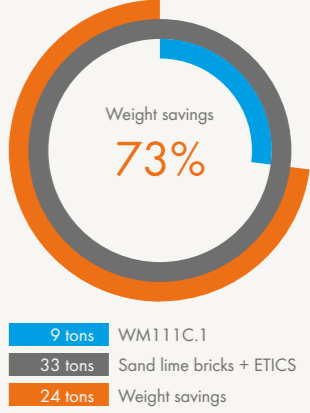

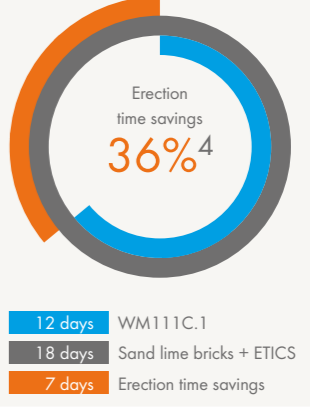
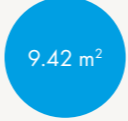
*Valid for a stud spacing of 600 mm and exterior profiles' web height of 100 mm **Calculated with INSUL (v9.0.1)

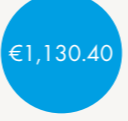
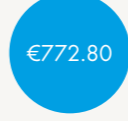
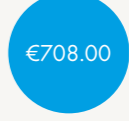







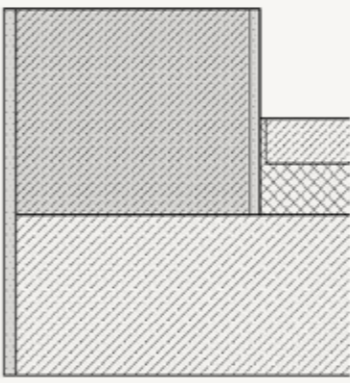
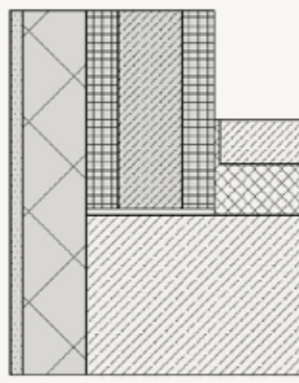
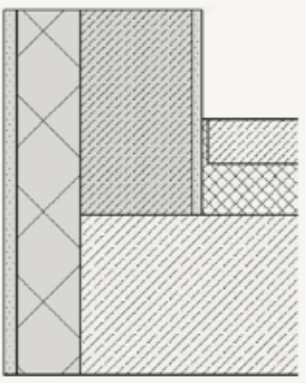

Economic advantages (example: floor extension)		compared with ...	Aerated concrete	Precast concrete parts + ETICS	Sand lime bricks + ETICS
Building perimeter (m): 58 m Floor height: 3 m Exterior wall surface per floor: 174 m ² Number of floors: 1 Wall opening share: 25% Opening surface: 43.50 m ² Net exterior wall surface: 130.50 m ²					
Cost-influencing factors ¹		compared with ...	Aerated concrete	Precast concrete parts + ETICS	Sand lime bricks + ETICS
Weight	<p>Based on a specific intended use and location of a building, the dead weight is the most important factor of the total loads, which can be influenced by planning. Basically, lower loads enable a leaner structure and thus significant cost savings.</p> <p>The calculation of explicit cost saving amounts for load-bearing walls and ceilings as well as foundations achieved by the weight reduction when using the Knauf Exterior Wall is generically not possible, since this is always to be calculated projectspecifically on the basis of floor plan geometries, spans and the load-bearing capacity of the building ground.</p>				
Erection time	<p>With a longer production time considerable costs for the personnel employment are connected, additionally a longer building process means a longer supply of building site facilities, whose costs should be minimised. The efficient construction of the Knauf Exterior Wall as well as the shorter drying times and the significantly lower weather dependency compared to massive constructions offer a considerable cost reduction potential and entail much less risk in the planning of the construction process.</p> <p>Additionally, if in masonry constructions, such as aerated concrete or sand-lime brick, the windows are not installed in the insulation layer, the openings must first be measured after erection of the exterior wall. Whereas with the Knauf Exterior Wall, manufacturers can work to precise plans and dimensions and therefore build windows in advance and transport them to the site, ready for immediate installation. A further advantage, which brings considerable time savings.</p>				
Revenue-influencing factors ¹		compared to ...	Aerated concrete	Precast concrete parts + ETICS	Sand lime bricks + ETICS
Space	<p>By using the Knauf Exterior Wall more space can be realised inside the building with a comparable thermal insulation value. Consequently, rentable space and resulting rental income are larger. For landlords and investors, the best possible use of the land area plays an important role. By using the Knauf Exterior Wall, this area efficiency and land utilisation are significantly improved.</p>				
Rental income					

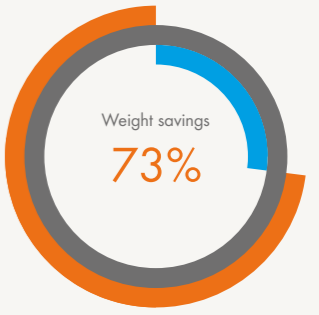
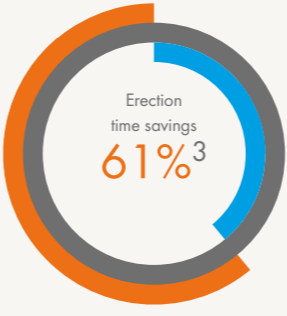
¹Figures are based on a study by Prof. Dr. Bert Bielefeld of the University of Siegen, Germany. All measurements use comparable U-values.

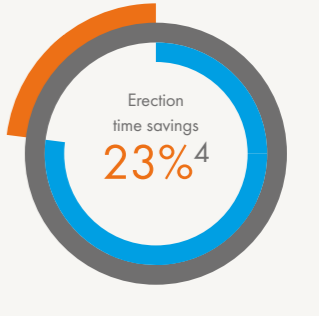
²Rental income based (in €/m² per month): 10.00€

³The time saved due to immediate window installation is taken into account.

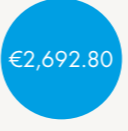
⁴If the windows are not installed in the insulation layer, the erection time savings increase to 49 days or 81%.

Economic advantages (example: retail shop)		compared with ...	Aerated concrete	Precast concrete parts + ETICS	Sand lime bricks + ETICS
<p>Building perimeter (m): 135 m</p> <p>Floor height: 5.5 m</p> <p>Exterior wall surface per floor: 742.5 m²</p> <p>Number of floors: 1</p> <p>Wall opening share: 50%</p> <p>Opening surface: 371.25 m²</p> <p>Net exterior wall surface: 371.25 m²</p>	 <p>Only a part of the building is shown.</p>				
Cost-influencing factors ¹		compared with ...	Aerated concrete	Precast concrete parts + ETICS	Sand lime bricks + ETICS
Weight	<p>Based on a specific intended use and location of a building, the dead weight is the most important factor of the total loads, which can be influenced by planning. Basically, lower loads enable a leaner structure and thus significant cost savings.</p> <p>The calculation of explicit cost saving amounts for load-bearing walls and ceilings as well as foundations achieved by the weight reduction when using the Knauf Exterior Wall is generically not possible, since this is always to be calculated projectspecifically on the basis of floor plan geometries, spans and the load-bearing capacity of the building ground.</p>		 <p>Weight savings 63%</p> <p>26 tons WM111C.1 70 tons Aerated concrete 44 tons Weight savings</p>	 <p>Weight savings 86%</p> <p>26 tons WM111C.1 189 tons Precast concrete parts + ETICS 163 tons Weight savings</p>	 <p>Weight savings 73%</p> <p>26 tons WM111C.1 95 tons Sand lime bricks + ETICS 69 tons Weight savings</p>
Erection time	<p>With a longer production time considerable costs for the personnel employment are connected, additionally a longer building process means a longer supply of building site facilities, whose costs should be minimised. The efficient construction of the Knauf Exterior Wall as well as the shorter drying times and the significantly lower weather dependency compared to massive constructions offer a considerable cost reduction potential and entail much less risk in the planning of the construction process.</p> <p>Additionally, if in masonry constructions, such as aerated concrete or sand-lime brick, the windows are not installed in the insulation layer, the openings must first be measured after erection of the exterior wall. Whereas with the Knauf Exterior Wall, manufacturers can work to precise plans and dimensions and therefore build windows in advance and transport them to the site, ready for immediate installation. A further advantage, which brings considerable time savings.</p>		 <p>Erection time savings 61%³</p> <p>28 days WM111C.1 71 days Aerated concrete 43 days Erection time savings</p>	 <p>Erection time savings 20%</p> <p>28 days WM111C.1 35 days Precast concrete parts + ETICS 7 days Erection time savings</p>	 <p>Erection time savings 23%⁴</p> <p>28 days WM111C.1 36 days Sand lime bricks + ETICS 8 days Erection time savings</p>
Revenue-influencing factors ¹		compared to ...	Aerated concrete	Precast concrete parts + ETICS	Sand lime bricks + ETICS
Space	<p>By using the Knauf Exterior Wall more space can be realised inside the building with a comparable thermal insulation value. Consequently, rentable space and resulting rental income are larger. For landlords and investors, the best possible use of the land area plays an important role. By using the Knauf Exterior Wall, this area efficiency and land utilisation are significantly improved.</p>		 <p>Space gain when using WM111C.1 compared to aerated concrete 22.44 m²</p>	 <p>Space gain when using WM111C.1 compared to precast concrete parts + ETICS 15.52 m²</p>	 <p>Space gain when using WM111C.1 compared to sand lime bricks + ETICS 14.23 m²</p>
Rental income			 <p>Additional income through rental (in €/year)² €2,692.80</p>	 <p>Additional income through rental (in €/year)² €1,862.40</p>	 <p>Additional income through rental (in €/year)² €1,707.60</p>

¹Figures are based on a study by Prof. Dr. Bert Bielefeld of the University of Siegen, Germany. All measurements use comparable U-values.

²Rental income based (in €/m² per month): 10.00€

³The time saved due to immediate window installation is taken into account.

⁴If the windows are not installed in the insulation layer, the erection time savings increase to 50 days or 64%.

CONSTRUCTION DRAWINGS

Section overview

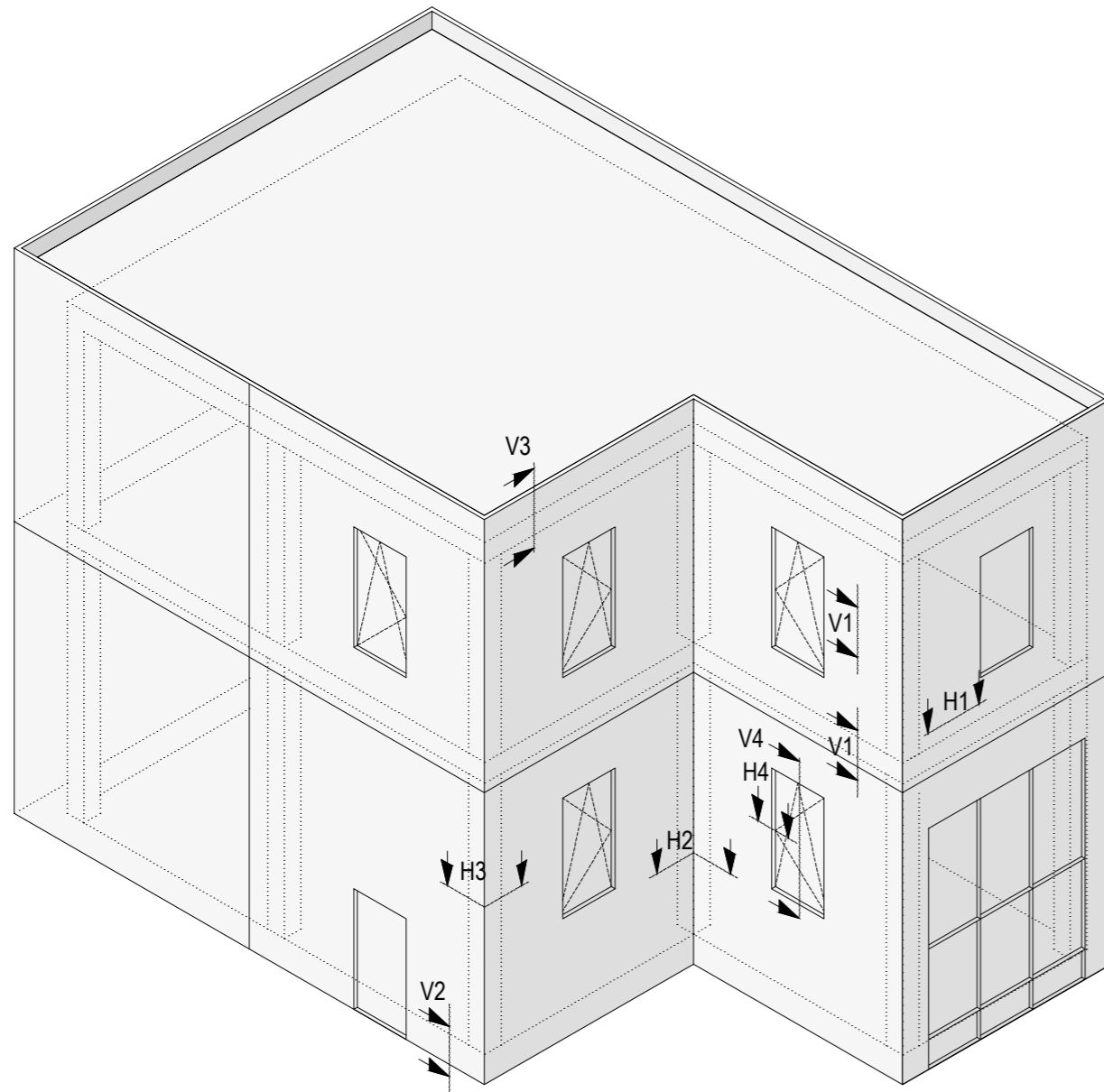

Index	Description
V1	Main section, vertical
V2	Vertical section - connection to base
V3	Vertical section - connection to parapet
V4.1	Vertical section window, lintel
V4.2	Vertical section window, parapet
H1	Main section, horizontal
H2	Horizontal section - interior corner without expansion joint
H3	Horizontal section - exterior corner without column
H4	Horizontal section window

Detail A: Vertical foil lining LDS and connection to floor slab

Details scale 1:2.5

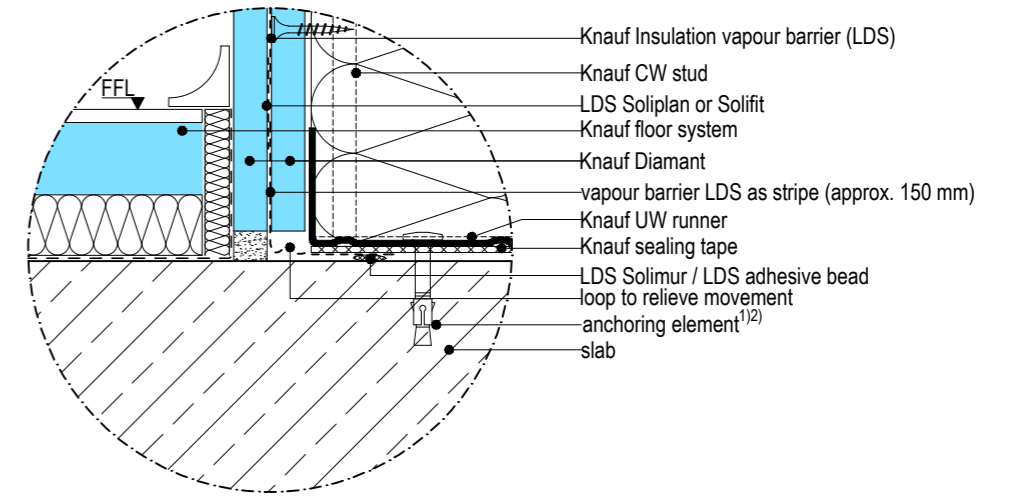

Detail B: Vertical foil lining LDS and connection to ceiling slab

Details scale 1:2.5

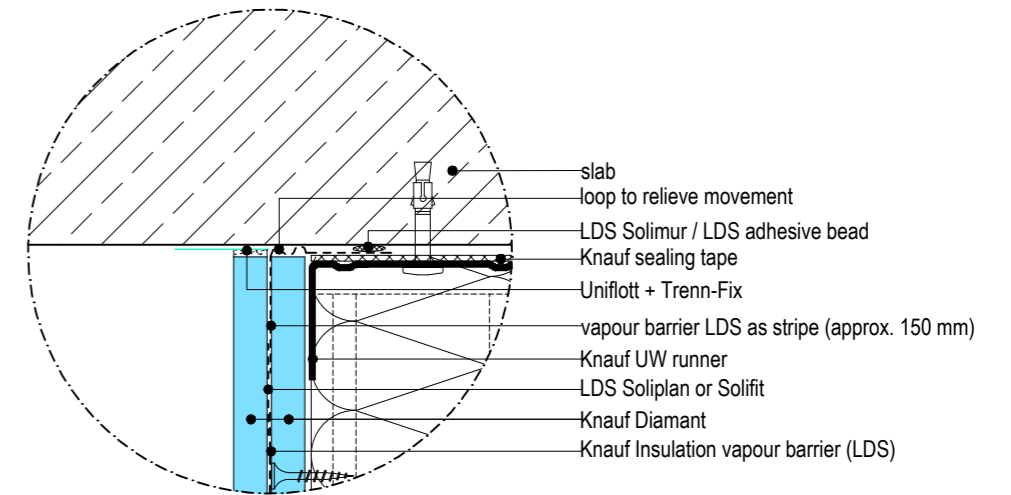

Detail C: Horizontal foil linings and connection to solid wall

Details scale 1:2.5

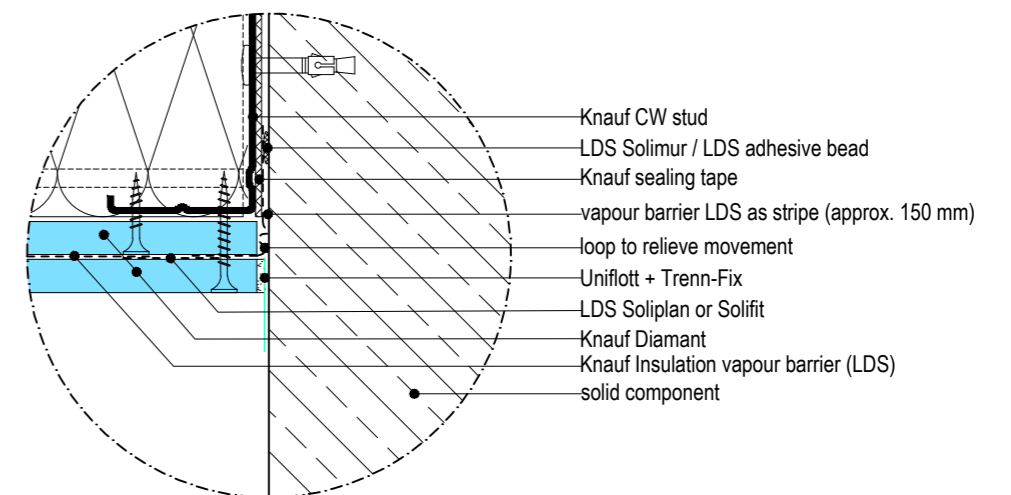

Notes

- › The drawings illustrating the general concept of how the system works and interfaces with other construction components.
- › The drawings do not substitute an execution design.
- › Follow the local standards and guidelines for the planning and structural design.
- › The technical specifications and information on the products given in the technical data sheets and system descriptions / approvals must be observed.

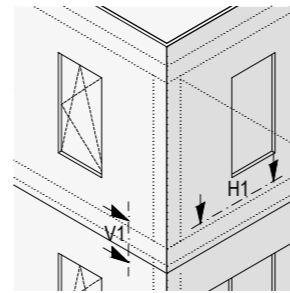

V1 Vertical section - connection to end plate

Details scale 1:5

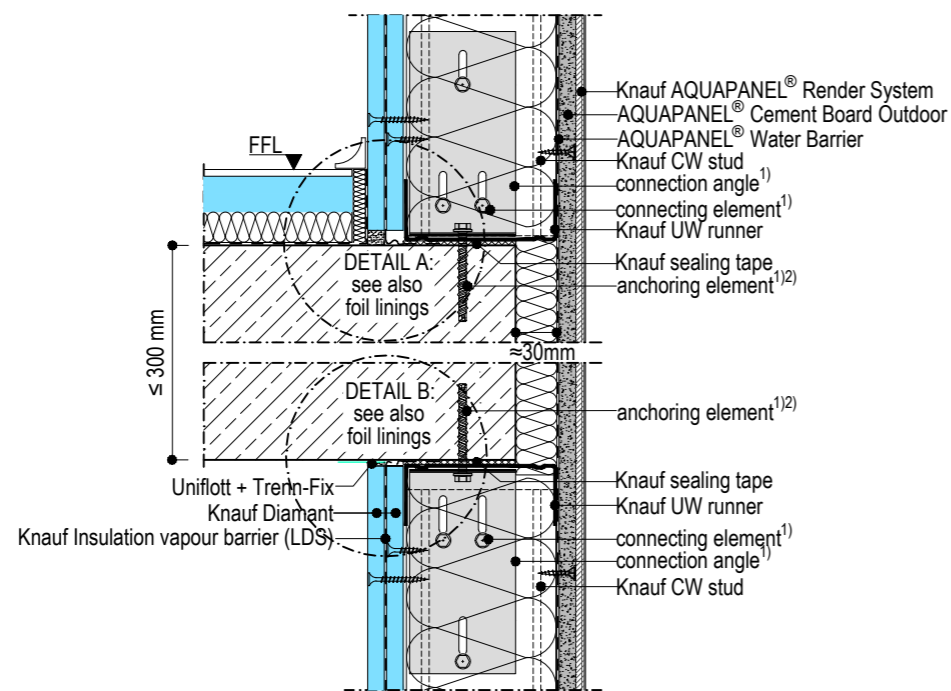

H1 Horizontal section - board joint

Details scale 1:5

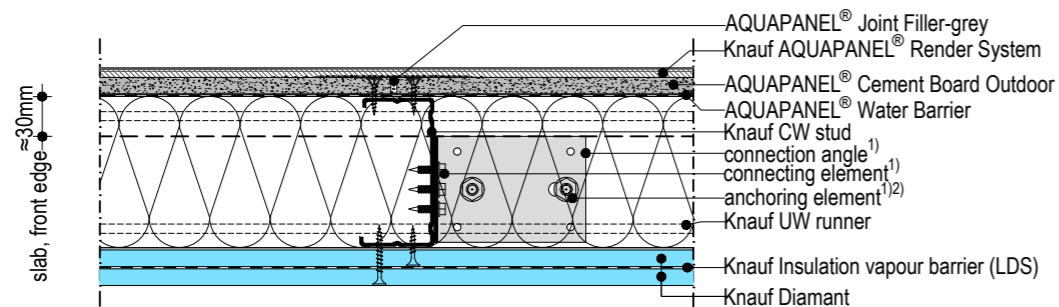

¹according to static wcalculation ²observe edge distance!

Notes

- › The drawings illustrating the general concept of how the system works and interfaces with other construction components.
- › The drawings do not substitute an execution design.
- › Follow the local standards and guidelines for the planning and structural design.
- › The technical specifications and information on the products given in the technical data sheets and system descriptions / approvals must be observed.

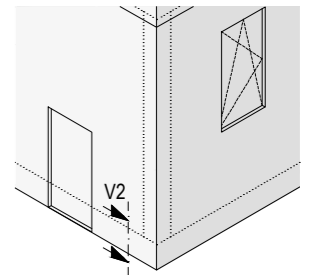

V2 Vertical section - connection to base

Details scale 1:5

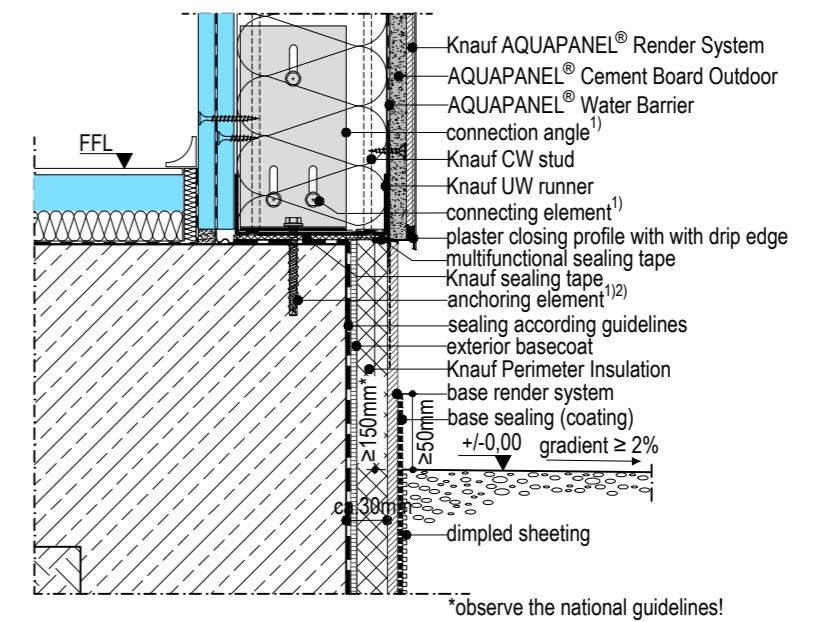

¹according to static calculation ²observe edge distance!

Notes

- › The drawings illustrating the general concept of how the system works and interfaces with other construction components.
- › The drawings do not substitute an execution design.
- › Follow the local standards and guidelines for the planning and structural design.
- › The technical specifications and information on the products given in the technical data sheets and system descriptions / approvals must be observed.

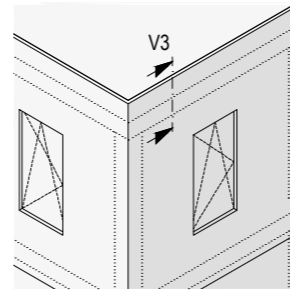

V3 Vertical section - connection to parapet

Details scale 1:5

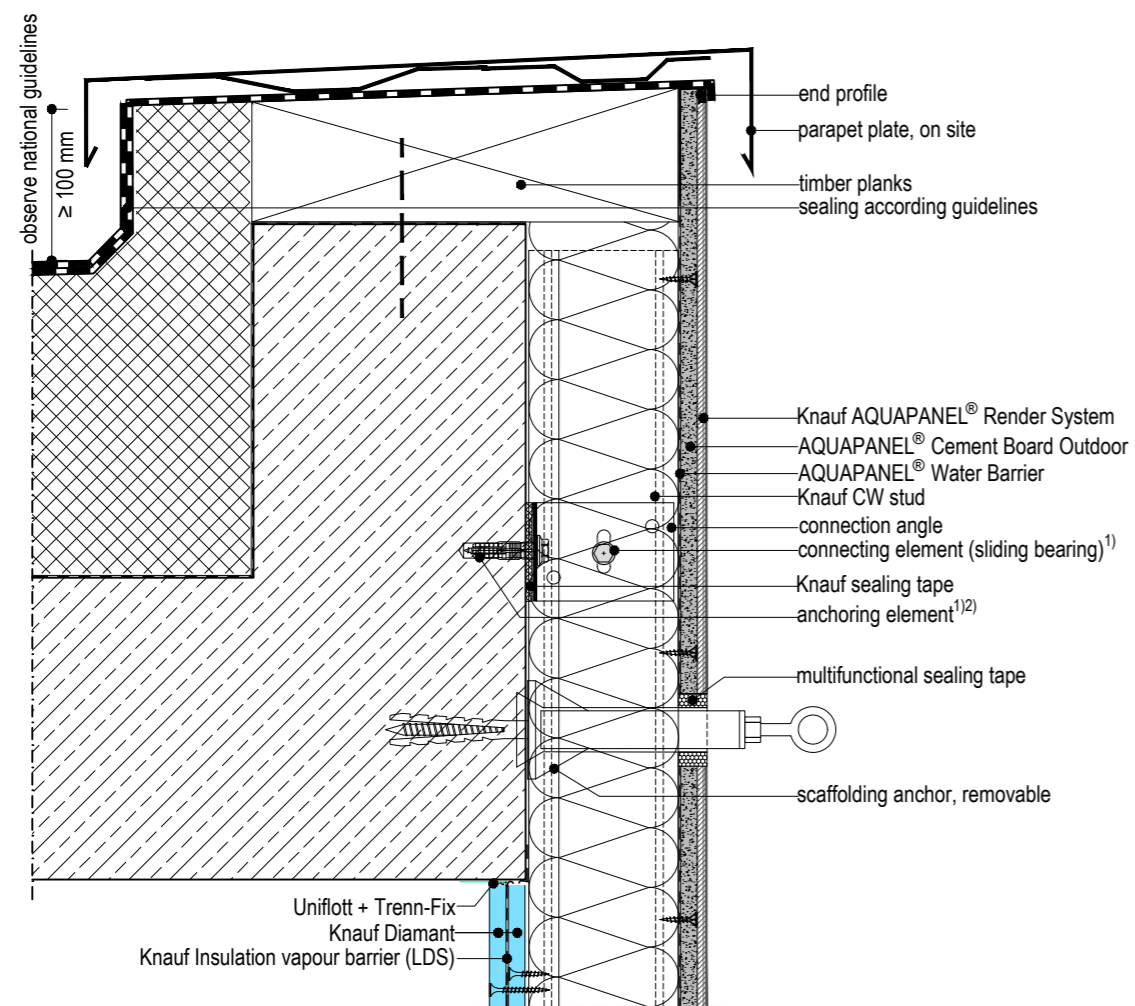

*observe the national guidelines!

¹⁾according to static calculation²⁾observe edge distance!**Notes**

- › The drawings illustrating the general concept of how the system works and interfaces with other construction components.
- › The drawings do not substitute an execution design.
- › Follow the local standards and guidelines for the planning and structural design.
- › The technical specifications and information on the products given in the technical data sheets and system descriptions / approvals must be observed.

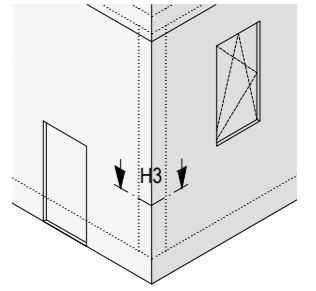

H3 Horizontal section - exterior corner without column

Details scale 1:5

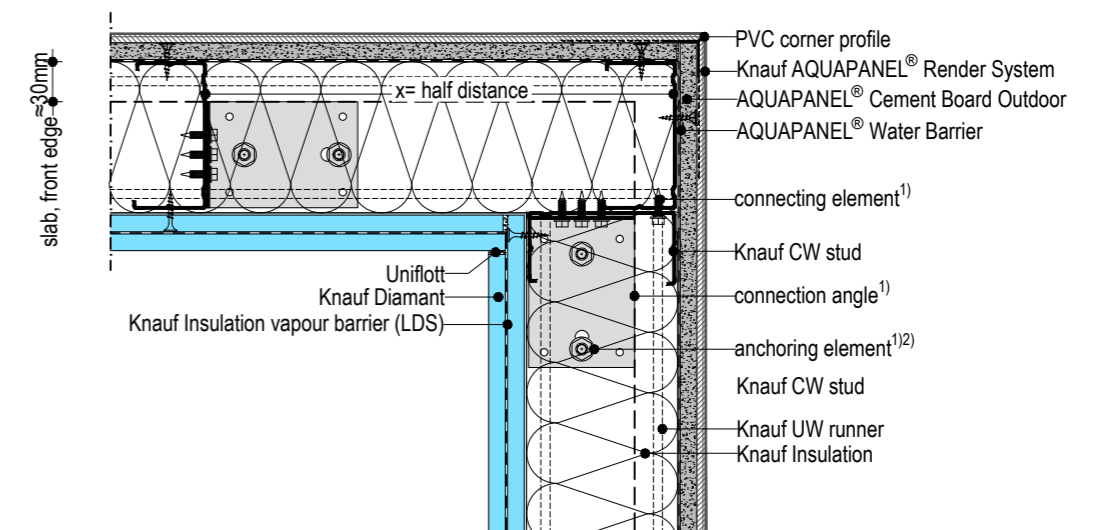
¹⁾according to static calculation²⁾observe edge distance!

Notes

- › The drawings illustrating the general concept of how the system works and interfaces with other construction components.
- › The drawings do not substitute an execution design.
- › Follow the local standards and guidelines for the planning and structural design.
- › The technical specifications and information on the products given in the technical data sheets and system descriptions / approvals must be observed.

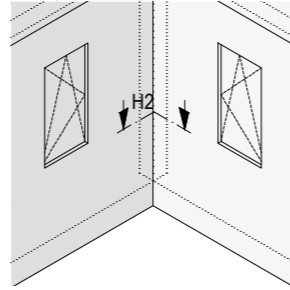

H2 Horizontal section - interior corner without expansion joint

Details scale 1:5

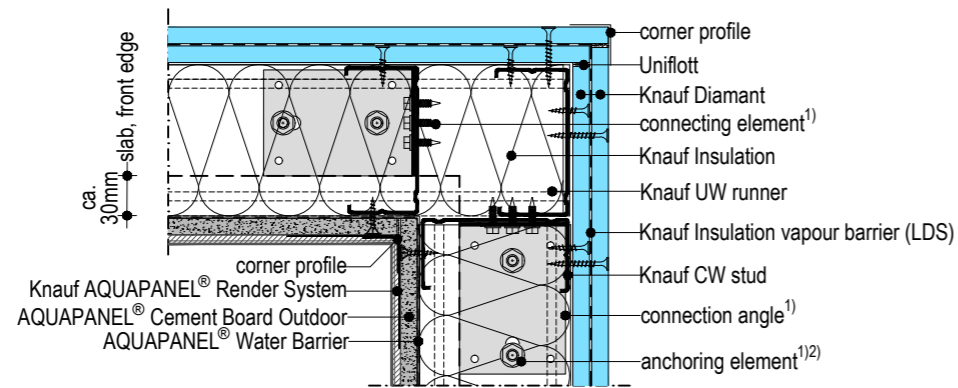

Notes

- › The drawings illustrating the general concept of how the system works and interfaces with other construction components.
- › The drawings do not substitute an execution design.
- › Follow the local standards and guidelines for the planning and structural design.
- › The technical specifications and information on the products given in the technical data sheets and system descriptions / approvals must be observed.

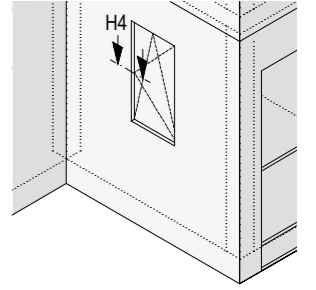

H4 Horizontal section - window

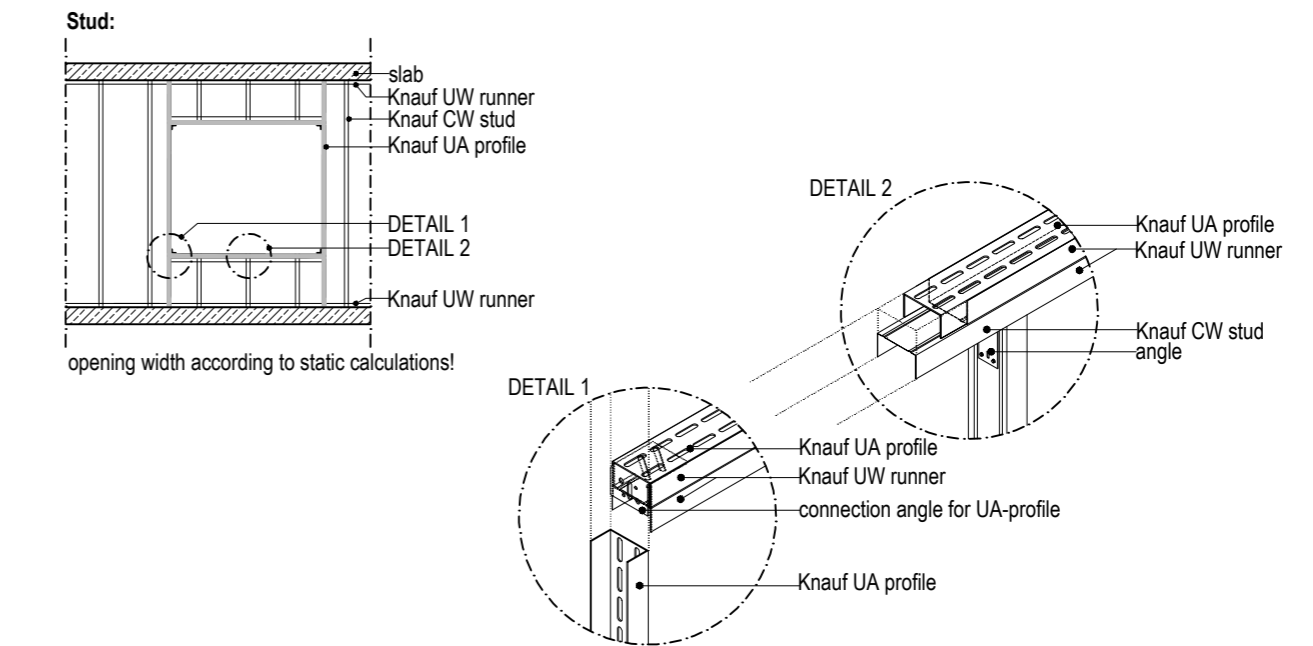

H4 Horizontal section - window

Details scale 1:5

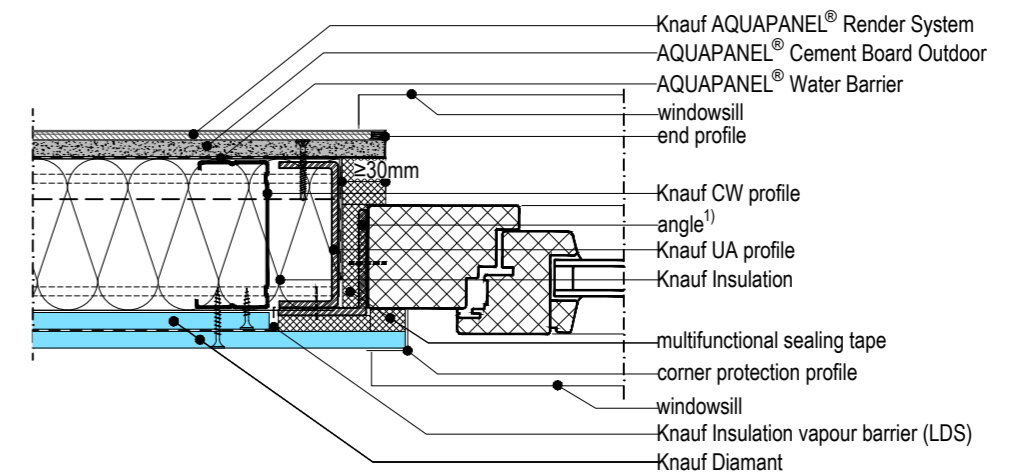

¹according to static calculation

²observe edge distance!

¹according to static calculation

²observe edge distance!

Notes

- › The drawings illustrating the general concept of how the system works and interfaces with other construction components.
- › The drawings do not substitute an execution design.
- › Follow the local standards and guidelines for the planning and structural design.
- › The technical specifications and information on the products given in the technical data sheets and system descriptions / approvals must be observed.

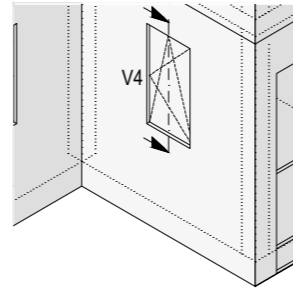

V4.1 Vertical section - lintel

Details scale 1:5

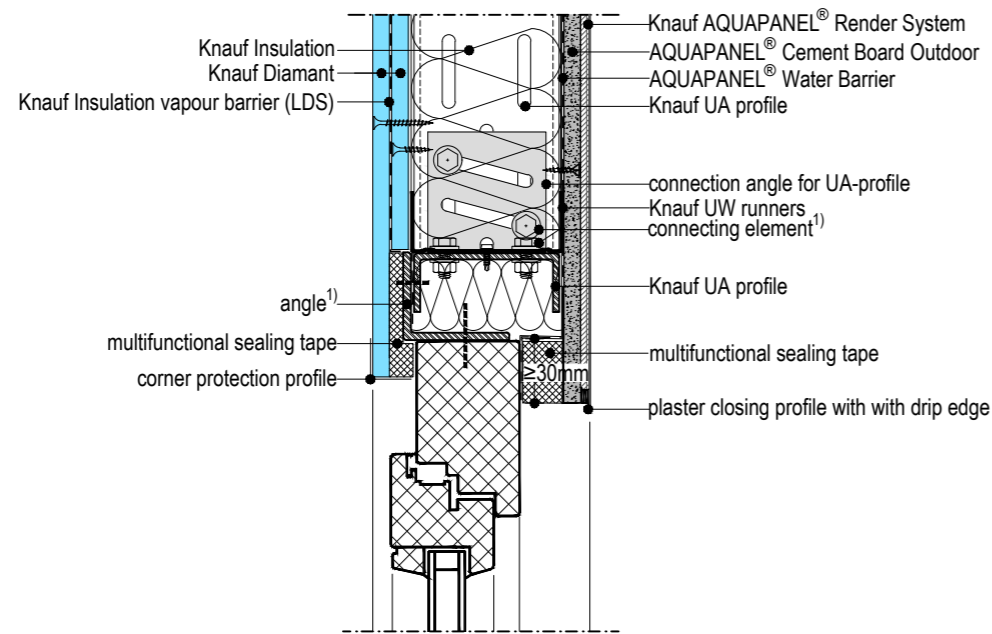

V4.2 Vertical section - parapet

Details scale 1:5

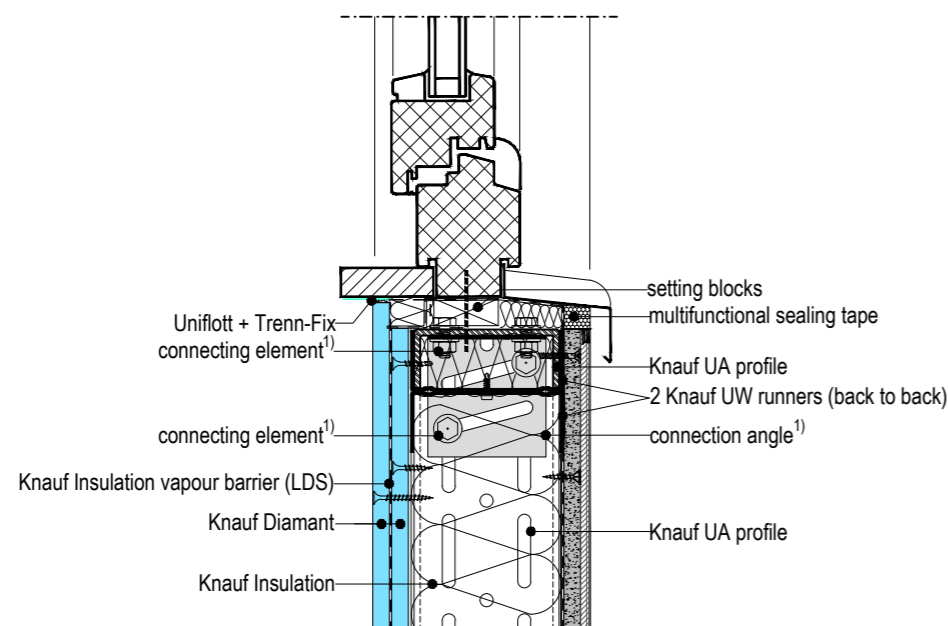

¹according to static calculation

²observe edge distance!

SPECIFICATIONS

Legend for text selections	
Optional items	Orange
Information to be supplemented by the contracting party	Blue

Item	Quantity	Performance description	Unit price	Total price
1		<p>Knauf Exterior Wall as single stud system, installed between floors, type WM111C.1.</p> <p>Non load-bearing exterior wall with cement-bonded board as exterior planking; inorganic and approved according to the building regulation, as substrate for different finishing materials and options; application in accordance with the manufacturer's guidelines</p> <p>One shell consisting of metal studs to include thermal insulation, described in details below; friction-locked and tension-free fixed to the floor slabs, and if necessary to columns and walls.</p> <p>The stud frame is consisting of CW or possibly UA profiles depending on static requirements. Friction-locked and tension-free connection to the floor slabs with UW runner and additional steel angle; type, dimension and quantity of the fasteners and fixing elements depending on structural requirements and to be approved according to the building regulations.</p> <p>The stud frame is to be aligned accurately and delivered as well as installed according to the following specification. Corrosion protection according to EN ISO 12944-2, but minimum Category C3.</p> <p>The following formal dimensions and cross-sections are minimum requirements. The application has to be carried out according to a verifiable structural analysis.</p> <p>Thermal insulation of the façade construction, consisting of: mineral insulation board according to EN 13162, non-combustible A1 according to EN 13501-1. Thermal conductivity $\lambda = 0.035 \text{ W/m}^2\text{K}$, water repellent.</p> <p>Constructional specifications:</p> <p>Thermal insulation: _____ $\text{W/m}^2\text{K}$</p> <p>Sound insulation: _____ dB (rated soundproofing)</p> <p>Fire protection: _____</p>		

Delete as applicable

Legend for text selections	
Optional items	Orange
Information to be supplemented by the contracting party	Blue

Item	Quantity	Performance description	Unit price	Total price
1.10		<p>Façade constructions and insulating materials</p> <p>Knauf Aquapanel single stud between floors, type WM111C.1</p> <p>Standard build-up – inside to outside (without fire protection requirement).</p> <p><u>The dimensions can vary according to static or constructive requirements:</u></p> <ul style="list-style-type: none"> › 12.5 mm gypsum board, Knauf wall board impregnated (GKBI/H2) › Knauf Insulation vapour barrier layer LDS 10 Silk › 12.5 mm gypsum board, Knauf wall board impregnated (GKBI/H2) › Knauf CW stud (according to static and constructional requirements) with thermal insulation board acc. to local requirements; stud distance: 600 or 400 mm incl. the fixation at top and bottom slab with adequate Knauf UW profiles and additional steel angle; incl. anchoring according to the static calculation › Aquapanel Water Barrier › Aquapanel Cement Board Outdoor with Aquapanel joint tape 10 cm and joint filler grey › Aquapanel exterior basecoat with Aquapanel reinforcing mesh <p>Deliver construct and assemble according to the enclosed planning and documentation in accordance with the manufacturer's instructions, complete and ready-made.</p> <p>000,000 m²</p>		

Delete as applicable

Legend for text selections	
Optional items	Orange
Information to be supplemented by the contracting party	Blue

Item	Quantity	Performance description	Unit price	Total price
1.20		<p>In addition – window opening</p> <p>The construction of a window opening, in addition to item 1.10, incl. connection work to the windows and window sills, interior and exterior.</p> <p>Opening size: L X W Other: Incl. all render profiles, sealing tapes, corner protection profiles, diagonal render reinforcements, etc.</p> <p>Deliver, construct and assemble according to the enclosed planning and documentation in accordance with the manufacturer's instructions, complete and ready-made.</p> <p>000,000 Unit</p>		
1.30		<p>In addition – door/gate opening</p> <p>The construction of a door/gate opening, in addition to item 1.10, incl. connection work to the door/gate, interior and exterior</p> <p>Opening size: L X W Other: Incl. all render profiles, sealing tapes, corner protection profiles, diagonal render reinforcements, etc.</p> <p>Deliver, construct and assemble according to the enclosed planning and documentation in accordance with the manufacturer's instructions, complete and ready-made.</p> <p>000,000 Unit</p>		
1.40		<p>In addition – metal-glass façade (Column and beam construction)</p> <p>The construction of an opening for a metal-glass façade, in addition to item 1.10 incl. connection work to the metal-glass façade, interiors and exteriors</p> <p>Opening size: L X W Other: Incl. all render profiles, sealing tapes, corner protection profiles, diagonal render reinforcements, etc.</p> <p>Deliver, construct and assemble according to the enclosed planning and documentation in accordance with the manufacturer's instructions, complete and ready-made.</p> <p>000,000 Unit</p>		

Delete as applicable

Legend for text selections	
Optional items	Orange
Information to be supplemented by the contracting party	Blue

Item	Quantity	Performance description	Unit price	Total price
1.50		<p>In addition – on-site penetration</p> <p>Construction of a penetration in addition to item 1.10 (e.g. pipes, emergency spillways, etc.); incl. connection work; use suitable sealing material, e. g. Compriband or similar, exteriors</p> <p>Opening size: L X W Other: Incl. all plaster strips, sealing tapes, corner protection rails, diagonal reinforcements, etc.</p> <p>Deliver, construct and assemble according to the enclosed planning and documentation in accordance with the manufacturer’s instructions, complete and ready-made.</p> <p>000,000 Unit</p>		
1.60		<p>In addition – outside corner of façade</p> <p>Construction of an external corner of a façade in addition to item 1.10, incl. all corner profiles, etc.</p> <p>Deliver, construct and assemble according to the enclosed planning and documentation in accordance with the manufacturer’s instructions, complete and ready-made.</p> <p>000,000 m</p>		
1.70		<p>In addition – inside corner of façade</p> <p>Construction of an internal corner of a façade in addition to item 1.10, incl. corner reinforcement, etc.</p> <p>Deliver, construct and assemble according to the enclosed planning and documentation in accordance with the manufacturer’s instructions, complete and ready-made.</p> <p>000,000 m</p>		

Delete as applicable

Legend for text selections	
Optional items	Orange
Information to be supplemented by the contracting party	Blue

Item	Quantity	Performance description	Unit price	Total price
1.80		<p>In addition – expansion joint (horizontal/vertical)</p> <p>Construction of system-related expansion joints in addition to item 1.10, incl. all expansion joint profiles</p> <p>Deliver, construct and assemble according to the enclosed planning and documentation in accordance with the manufacturer’s instructions, complete and ready-made.</p> <p>000,000 m</p>		
1.90		<p>In addition – structural joint</p> <p>Construction of a structural joint in addition to item 1.10, incl. all expansion joint profiles.</p> <p>Deliver, construct and assemble according to the enclosed planning and documentation in accordance with the manufacturer’s instructions, complete and ready-made.</p> <p>000,000 m</p>		

Delete as applicable

Legend for text selections	
Optional items	Orange
Information to be supplemented by the contracting party	Blue

Item	Quantity	Performance description	Unit price	Total price
1.1		Surface treatment – exterior façade		
1.1.10		<p>Priming of façade surface</p> <p>Priming of the façade surface with application of the system-compatible AQUAPANEL® Basecoat Primer; prime the entire surface.</p> <p>Miscellaneous: incl. reveals and lintels</p> <p>Deliver, construct and assemble according to the enclosed planning and documentation in accordance with the manufacturer’s instructions, complete and ready-made.</p> <p>000,000 m²</p>		
1.1.20		<p>Exterior finish</p> <p>Deliver AQUAPANEL® Exterior Mineral Finish – white, applied on entire surface, grain size 2 mm, structure and colour according to architect’s specification; align accurately and remove the render to grain size.</p> <p>Location: elevation no. : _____ axis no. : _____</p> <p>Colour: according to architect’s specification</p> <p>Miscellaneous: incl. reveals and lintels</p> <p>Deliver, construct and assemble according to the enclosed planning and documentation in accordance with the manufacturer’s instructions, complete and ready-made.</p> <p>000,000 m²</p>		

Delete as applicable

Legend for text selections	
Optional items	Orange
Information to be supplemented by the contracting party	Blue

Item	Quantity	Performance description	Unit price	Total price
1.1.30		<p>*** Optional item</p> <p>Exterior finish</p> <p>AQUAPANEL® Exterior Dispersion Plaster – white, applied on entire surface, structure and colour according to architect’s specification, align accurately and remove the render to grain size.</p> <p>Location: elevation no. : _____ axis no. : _____</p> <p>Colour: according to architect’s specification</p> <p>Miscellaneous: Incl. reveals and lintels</p> <p>Deliver, construct and assemble according to the enclosed planning and documentation in accordance with the manufacturer’s instructions, complete and ready-made.</p> <p>000,000 m²</p>		
1.1.40		<p>*** Optional item</p> <p>Exterior finish</p> <p>AQUAPANEL® Silicon Synthetic Resin Plaster – white, applied on entire surface, structure and colour according to architect’s specification, align accurately and remove the render to grain size.</p> <p>Location: elevation no. : _____ axis no. : _____</p> <p>Colour: according to architect’s specification</p> <p>Miscellaneous: Incl. reveals and lintels</p> <p>Deliver, construct and assemble according to the enclosed planning and documentation in accordance with the manufacturer’s instructions, complete and ready-made.</p> <p>000,000 m²</p>		

Delete as applicable

Legend for text selections	
Optional items	Orange
Information to be supplemented by the contracting party	Blue

Item	Quantity	Performance description	Unit price	Total price
1.2		Surface treatment interiors		
1.2.10		<p>Interior finish – gypsum board</p> <p>Filling the joints of gypsum boards with Knauf Uniflott and cover the screw heads, quality level Q2</p> <p>Location: elevation no. : _____ axis no. : _____</p> <p>Miscellaneous: Incl. reveals and lintels</p> <p>Deliver, construct and assemble according to the enclosed planning and documentation in accordance with the manufacturer’s instructions, complete and ready-made.</p> <p>000,000 m²</p>		

Delete as applicable

Legend for text selections	
Optional items	Orange
Information to be supplemented by the contracting party	Blue

Item	Quantity	Performance description	Unit price	Total price
1.3		Further services		
1.3.10		<p>*** Optional item: Scaffolding brackets</p> <p>GELOG scaffolding brackets for the described wall structure, dimensioning according to statics. Deliver, construct and assemble according to the enclosed planning and documentation in accordance with the manufacturer’s instructions, complete and ready-made.</p> <p>000,000 Unit</p>		
1.3.20		<p>Detail and implementation planning</p> <p>Preparation of the detail and implementation planning, incl. the details and installation plans for the steel substructure and the AQUAPANEL® Cement Board Outdoor as well as the anchoring system.</p> <p>Before execution, all planning and construction results have to be signed off by the contractor and the structural engineer.</p> <p>1 lump sum</p>		
1.3.30		<p>Proof of stability</p> <p>Preparation of verifiable static calculation of the substructure, incl. screw connections, dowels, anchors, etc. This must be submitted by the contractor before start of execution and signed off by the responsible inspecting structural engineer.</p> <p>1 lump sum</p>		
1.3.40		<p>*** Optional item: Mock-up</p> <p>Creation of a complete mock-up, Size: approx. a x b m Location: elevation no. : _____ axis no. : _____</p> <p>Mock-up for subsequent incorporation into the façade / Mock-up has to be removed afterwards / Mock-up will be erected separately from site (location to be defined)</p> <p>If necessary in coordination with other disciplines as specified by the architect.</p> <p>Deliver, construct and assemble according to the enclosed planning and documentation in accordance with the manufacturer’s instructions, complete and ready-made.</p> <p>1 lump sum</p>		

Delete as applicable

PRODUCT RANGE

Stud framework



Easy to work with and install, the components used to create our stud frames include profiles, angles, screws and sealing strips, all available in a wide range of specifications and geometries to meet any design requirement. All profiles have organic coating and galvanizing (minimum corrosion category C3 according to EN ISO 12944) to ensure long-term protection.

Profiles		Web height (mm)	Flange width (mm)	Nominal thickness (mm)	Weight (approx kg/m)
CW Profiles	<ul style="list-style-type: none"> Point of use: exterior and interior stud frame Black coated Minimum corrosion protection C3 	50	50	0.6	0.7
		75			0.8
		100			0.9
		125			1.0
		150			1.2
UW Profiles	<ul style="list-style-type: none"> Point of use: exterior and interior stud frame Black coated Minimum corrosion protection C3 	50	40	0.6	0.5
		75			0.7
		100			0.8
		125			0.9
		150			1.0

Profiles		Web height (mm)	Flange width (mm)	Nominal thickness (mm)	Weight (approx kg/m)		
UA Profiles	<ul style="list-style-type: none"> Point of use: exterior and interior stud frame Black coated Minimum corrosion protection C3 With single-row perforation (web height 50mm) or two-row perforation (web height 75-100mm) 	50	40	2.0	1.7		
		75			2.0		
		100			2.3		
Connecting angles				Width (mm)	Length (mm)	Nominal thickness (mm)	
Anschlusswinkel (Korrosionsschutz C3 - C5M)	<ul style="list-style-type: none"> Black coated Package incl. 8 rotary pin dowels 6/60mm, 8 carriage bolts M 8/25 mm, 8 nuts M8, 8 washers For UA profiles 		50	80	1.5		
			75				
			100				
Screws and anchors				Width (mm)	Length (mm)		
Deckennagel Korrosionsschutz A4	<ul style="list-style-type: none"> Rustproofed steel A4 To attach steel profiles to reinforced concrete Borehole diameter: 6mm Borehole depth: 45mm Also for fire-protection constructions 			6.0	30		
Universal-Schraube FN	<ul style="list-style-type: none"> To connect clips or suspension devices to timber and metal Incl. one bit/package 			4.3	35 65		
Decoupling tape				Width (mm)	Roll length (mm)	Thickness (mm)	Nominal thickness (mm)
Decoupling tape	<ul style="list-style-type: none"> Self-adhesive on one side To separate profiles from connections to walls, ceilings, columns and floor connections To reduce thermal and sound bridges In double stud systems used only in interior stud frame 		30	30,000	3.2	1.5	
			50				
			70				
			95				



Insulation



Available in panels and rolls for easy installation, mineral wool from Knauf Insulation is suitable for a wide range of applications, including inside stud frames, in the space between interior and exterior frames, as well as in front of floors to reduce thermal bridges between the Knauf Exterior Wall with AQUAPANEL Technology® and concrete slabs.

Insulation for metal constructions			Width (mm)	Length (mm)	Thickness (mm)	m ² /Package
Knauf Insulation Metallbau-Dämmplatte FCB 035 	<ul style="list-style-type: none"> › Insulation board › Thermal conductivity rating: 035 › Glass mineral wool › ECOSE® Technology › Non-combustible 	625	1,250	50	9.38	
				75	6.25	
				150	3.13	
Knauf Insulation Universalrolle classic 035 	<ul style="list-style-type: none"> › Insulation roll › Thermal conductivity rating: 035 › Glass mineral wool › ECOSE® Technology › Non-combustible 	1,200	13,000	40	15.60	
			10,500	50	12.60	
			8,700	60	10.44	
			6,300	80	7.56	
			5,200	100	6.24	
			4,400	120	5.28	
			3,700	140	4.44	
			3,300	160	3.96	
			2,900	180	3.48	
			2,600	200	3.12	
			2,900	220	3.48	
			2,700	240	3.24	

Exterior lining



To ensure that the Knauf Exterior Wall acquires its water resistant properties, AQUAPANEL® Cement Board Outdoor is fitted on top of AQUAPANEL® Water Barrier, a highly windproof, rainproof and permeable layer which can be easily fixed on exterior studs by using adhesive tape. Complemented with specially developed system accessories including AQUAPANEL® Joint Filler, AQUAPANEL® Tape as well as AQUAPANEL® Maxi Screws with special coatings for added corrosion protection, the result is a complete – and completely reliable – lining system of AQUAPANEL® products.

Water barrier			Width (mm)	Roll Length (mm)		
AQUAPANEL® Water Barrier 	<ul style="list-style-type: none"> › Water resistant and wind tight membrane › Used as a water conducting layer directly behind AQUAPANEL® Cement Board Outdoor › Diffusion equivalent air layer thickness (sd): 0.025m 	1,500	50,000			
Adhesive tapes			Width (mm)	Roll Length (mm)		
Knauf Insulation LDS Solitop 	<ul style="list-style-type: none"> › One-sided reinforced adhesive tape made of polyethylene › Specially developed for outdoor use › Used for bonding overlaps and penetrations of the AQUAPANEL® Water Barrier 	60	40,000			
		150	25,000			
Cement boards			Width (mm)	Length (mm)	Thickness (mm)	Weight (approx kg/m ²)
AQUAPANEL® Cement Board Outdoor 	<ul style="list-style-type: none"> › Cement board › Easy Edge™ › Building material class: A1, non-combustible › 100% water resistant › Bending radius 1-3m (in dry state) 	900	1,200	12.5	16	
		900	1,250			
		900	2,400			
		900	2,500			
		1,200	900			
		1,200	2,000			
		1,200	2,400			
		1,200	2,500			
		1,200	2,800			
		1,200	3,000			
		1,250	900			
		1,250	2,000			
		1,250	2,500			

Screws			Length (mm)
AQUAPANEL® Maxi Screw SN25		▶ With countersunk head and nail tip	25
AQUAPANEL® Maxi Screw SN39			29
AQUAPANEL® Maxi Screw SN55			55
AQUAPANEL® Maxi Screw SB25		▶ With countersunk head and drill tip	25
AQUAPANEL® Maxi Screw SB39			39



Material of substructure	Steel framework				
	0.6mm ≤ x ≤ 1.0mm			1.0mm < x ≤ 2.0mm	
Amount of board layers	Single layer	Double layer	Triple layer	Single layer	Double layer
AQUAPANEL® Maxi Screw SN25	x				
AQUAPANEL® Maxi Screw SN39	x	x			
AQUAPANEL® Maxi Screw SN55			x		
AQUAPANEL® Maxi Screw SB25				x	
AQUAPANEL® Maxi Screw SB39				x	x

Joint filler			Coverage (ca kg/m²)	Storage life (approx month)	Weight (kg/bag)
AQUAPANEL® Joint Filler – grey		<ul style="list-style-type: none"> ▶ Cement-bound joint filling material ▶ Full-surface skimcoating of joints ▶ Reinforced with AQUAPANEL® Tape 10cm 	0.7	12	20

Joint tapes			Width (mm)	Roll length (mm)
AQUAPANEL® Tape 10cm		<ul style="list-style-type: none"> ▶ Glass fabric joint tape ▶ Alkali-resistant coating ▶ Colour: blue ▶ Mesh size: 4x4mm 	100	50,000
				20,000
AQUAPANEL® Exterior Reinforcing Tape		<ul style="list-style-type: none"> ▶ Glass fabric joint tape ▶ Alkali-resistant coating ▶ Colour: blue ▶ Mesh size: 4x4mm 	200	50,000

Exterior finishing

Knauf Exterior Wall is able to accommodate a wide range of finishes, so whatever you want to achieve, it's achievable. In terms of render, AQUAPANEL® has a range of products in its portfolio, including AQUAPANEL® Exterior Basecoat, AQUAPANEL® Reinforcing Mesh, AQUAPANEL® Basecoat Primer and a range of finishing renders. In addition, Knauf offers a selection of renders to increase choice and design possibilities. Knauf Exterior Wall is also compatible with a wide range of third-party finishes, including cladding, brick slips, tiles and paint, so there is no limit on design potential.







Basecoats			Coverage (ca kg/m²)	Storage life (approx month)	Weight (kg/bag)
AQUAPANEL® Exterior Basecoat		<ul style="list-style-type: none"> ▶ Cement-based, synthetic resin-enhanced basecoat ▶ Colour: grey ▶ Used for basecoating AQUAPANEL® Cement Board Outdoor when finishing with a thin layer of finishing plaster, decorative render or paint 	7.8 (with 5mm layer thickness)	12	25
AQUAPANEL® Exterior Basecoat – white		<ul style="list-style-type: none"> ▶ Cement-based, synthetic resin-enhanced basecoat ▶ Colour: white ▶ Used for basecoating AQUAPANEL® Cement Board Outdoor when finishing with a thin layer of finishing plaster, decorative render or paint 	6.3 (with 5mm layer thickness)	12	25
Reinforcing mesh			Width (mm)	Roll length (mm)	
AQUAPANEL® Reinforcing Mesh		<ul style="list-style-type: none"> ▶ Alkali-resistant coating ▶ Colour: blue ▶ Used to reinforce AQUAPANEL® Exterior Basecoat and AQUAPANEL® Exterior Basecoat – white ▶ Mesh size: 4x4mm ▶ Initial tear strength: approx. 2200 N/5cm ▶ Approx. 160g/m² 	1,000	50,000	



Basecoat primer		Coverage (approx kg/m ²)	Storage life (approx month)	Weight (kg/bucket)
AQUAPANEL® Basecoat Primer 	<ul style="list-style-type: none"> › Synthetic dispersion › Alkali-resistant › Colour: white › Used as a primer on AQUAPANEL® Exterior Basecoat and AQUAPANEL® Exterior Basecoat - white where AQUAPANEL® render finishes are used › Reduces suction variations 	7.8 (with 5mm layer thickness)	12	15
Finishing renders		Coverage (approx kg/m ²)	Storage life (approx month)	Weight (kg/unit)
AQUAPANEL® Exterior Mineral Finish – white 	<ul style="list-style-type: none"> › Mineral finishing render › For use on top of AQUAPANEL® Exterior Basecoat and AQUAPANEL® Exterior Basecoat - white › Grain size: 2mm › Can be used as a smooth floating finishing render or freely structured using different tools and designs 	3.0 (with 2mm layer thickness)	12	30
AQUAPANEL® Exterior Dispersion Plaster – white 	<ul style="list-style-type: none"> › Ready-to-use › Pasty consistency › Water-repellent › Allows diffusion › Prevents fungal attack › For application on AQUAPANEL® Exterior Basecoat and AQUAPANEL® Exterior Basecoat - white › Grain size: 2mm 	3.1	24	25
AQUAPANEL® Exterior Silicon Synthetic Resin Plaster – white 	<ul style="list-style-type: none"> › Ready-to-use › Pasty consistency › Water-repellent › Allows diffusion › Prevents fungal attack › For application on AQUAPANEL® Exterior Basecoat and AQUAPANEL® Exterior Basecoat - white › Grain size: 2mm 	3.1	24	25

Interior lining

Knauf Exterior Wall systems include an unrivalled choice of fully compatible lining boards to meet any specification need, including moisture rating, impact resistance, fire rating and sound reduction. For specialist applications in wet and humid areas, AQUAPANEL® Cement Board Indoor has been specifically developed to provide a robust and reliable solution, including in swimming pools and steam saunas. All boards come with comprehensive accessories including vapour control layers, sealant tapes, joint fillers, adhesives and screws.

Vapour barriers		Width (mm)	Roll length (mm)
Knauf Insulation LDS 10 Silk 	<ul style="list-style-type: none"> › Vapour control membrane made of high strength polypropylene spun-bonded fabric › Diffusion equivalent air layer thickness (sd): 10m › Approx 140g/m² 	3,000	50,000
Adhesive tapes		Width (mm)	Roll length (mm)
Trenn-Fix 	<ul style="list-style-type: none"> › Special coated paper strip › Adhesive along one edge › Used as separation strip between dry-built surfaces and other constructional elements › Used between dry-built surfaces to generate a sliding separation 	65	50,000
Knauf Insulation LDS Soliplan 	<ul style="list-style-type: none"> › One-sided adhesive tape made of kraft paper › Used for durable air-tight bonding of vapour barrier overlaps and fitting edges 	60	40,000
Knauf Insulation LDS Solitwin 	<ul style="list-style-type: none"> › One-sided reinforced adhesive tape made of low-density polyethylene (LDPE) › With centre-slit backing paper › Used for durable and elastic air-tight bonding of the vapour barrier in corner areas and window connections 	60	25,000
Knauf Insulation LDS Solifit 	<ul style="list-style-type: none"> › One-sided reinforced adhesive tape made of low-density polyethylene (LDPE) › Used for durable and elastic air-tight bonding of vapour barrier overlaps and penetrations, when flexible connections are necessary (e.g. pipes, beams, etc.) 	60	25,000
Knauf Insulation LDS Solifit S 	<ul style="list-style-type: none"> › One-sided reinforced adhesive tape made of low-density polyethylene (LDPE) › Used for durable and elastic air-tight bonding of vapour barrier overlaps and penetrations, when flexible connections are necessary (e.g. pipes, beams, etc.) › No peeling, collection and disposal of the release paper required › Easy handling by finger lift › Tape tears by hand 	60	25,000
Knauf Insulation LDS Kleberaube 	<ul style="list-style-type: none"> › Elastic, double-sided adhesive tape › Used for safe, durable and elastic bonding of the vapour barrier to flanking building parts 	25	8,000

Liquid adhesive		Capacity (ml)	Storage life (approx month)			
Knauf Insulation LDS Solimur 	<ul style="list-style-type: none"> Elastic, durably strong special adhesive Used for safe, durable and elastic bonding of the vapour barrier to flanking building parts 	600	24			
		310	24			
Adhesive primer		Coverage (approx m)	Storage life (approx month)			
Knauf Insulation LDS Primer 	<ul style="list-style-type: none"> Dispersion-based adhesive primer To enhance adhesion of LDS adhesive tapes and LDS Solimur to porous substrates to guarantee a durable adhesive bond 	25-30 (100mm application width)	18			
Air-tight sleeves		Diameter (mm)	Width (mm)	Length (mm)		
Knauf Insulation LDS Universalmanschette 	<ul style="list-style-type: none"> Multi-purpose sleeve Two-layer polypropylene spun-bonded fabric For fast and professional, in particular retrospective sealing of pipe openings in the vapour barrier 	75-125	400	400		
Knauf Insulation LDS Leitungsmanschette 	<ul style="list-style-type: none"> Cable sleeve Self-adhesive kraft paper For professional sealing of cable feed-throughs 	8-12	150	150		
Knauf Insulation LDS Leitungsmanschette 6-fach 	<ul style="list-style-type: none"> Cable sleeve Non-woven polyethylene For professional sealing of up to 6 cable feed-throughs 	4-11	230	230		
Gypsum boards		Width (mm)	Length (mm)	Thickness (mm)	Weight (approx kg/m ²)	
Impregnated Gypsum Board 12.5mm (GKBI/H2) 	<ul style="list-style-type: none"> Used in all fields of interior works as economic cladding of drywall systems in rooms with a constant relative air humidity of ≤ 70 % (e.g. domestic bathrooms) Impregnated for reduced water absorption Colour of board liner: green Non-combustible Long edges: Half-rounded tapered edges Front edges: cut edges GKBI according to DIN 18180 H2 according to EN 520 	1,250	2,000	12.5	9.4	
			2,500			
			3,000			

Drywall screws		Width (mm)	Length (mm)	
Schnellbauschraube TN Feingewinde 	<ul style="list-style-type: none"> To fix impregnated gypsum boards (GKBI / H2) to metal substructures Bugle head Nail tip Double, fine-pitched thread Metal thickness ≤ 0.7mm Incl. one bit/package 	3.5	25	
			35	
Schnellbauschraube TB 	<ul style="list-style-type: none"> To fix impregnated gypsum boards (GKBI / H2) to metal substructures Bugle head Drill tip Metal thickness: 0.7mm < x ≤ 2.25mm Incl. one bit/package 	3.5	25	
			45	
Gypsum filler		Coverage (approx. kg/m ²)	Storage life (approx month)	Weight (kg/bag)
Uniflott 	<ul style="list-style-type: none"> Gypsum filler for hand filling joints of drywall systems Low drying shrinkage Very high crack resistance Quick drying and development of hardness Application in interiors for gypsum boards or composite boards with half-rounded edge (HRK) or half-rounded tapered edge (HRAK) without joint tape on paper liner covered edges with a metal stud frame 	0.5	9	5
				25

Interior finishing

From primers, renders, skim coatings and paint, Knauf offers a full range of surface finishes for every need – from standard to high-end Q4 specifications with minimal marks, traces or shading caused by shallow light angles. The end result will depend on the decorative finish required as well as the skills of the contractor.

Finishing plaster		Coverage (approx. kg/m ²)	Storage life (approx month)	Weight (kg/bag)
Super Finish 	<ul style="list-style-type: none"> Ready-to-use, all-purpose filler Suitable as joint finish (Q2), for full-surface filling (quality grades Q3 and Q4), as well as smoothing numerous substrates 	1.6	12	20



PRODUCT HANDLING

Boards



- › Always carry the boards upright, or use board rollers. Handle with fork lift or crane as palletted goods. Take care not to damage corners and edges when setting the boards down. Place boards down on their long edge before laying them flat.

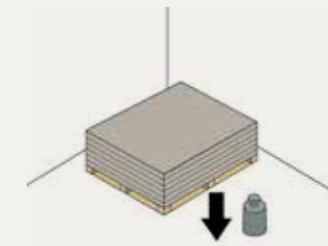

- › Ensure that the base is strong enough to support the boards.



- › Protect boards from moisture and weathering before they are installed. Boards which have become damp must be dried on both sides on a flat surface prior to fitting. Before installing, condition the boards to the ambient temperature and humidity.

Profiles

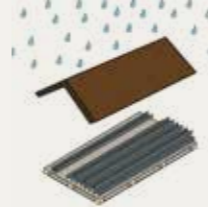

- › Protect profiles from moisture and weathering before they are installed. Products should not be left permanently exposed to the elements.

Powder materials



- › Store bags in a dry place and in original packaging.



- › Do not apply joint fillers, basecoat or finishing materials in temperatures less than +5°C.

Health and safety

- › Avoid unnecessary dust on job site when using electrical saw. Keep sanding and other dust generation to a minimum. Maintain adequate ventilation and/or wear suitable protection.
- › Exercise care when using power tools and take all necessary precautions.
- › Follow instructions on packaging when applying system accessories.
- › When using powdered products, mix with water in well-ventilated conditions. Avoid contact with eyes and skin. In the event of contact with the eyes, irrigate with plenty of clean water immediately.
- › When handling insulation or cutting boards which contain glassfibre, wear suitable protection including face mask and gloves. Wear protective glasses when working overhead.
- › Follow national health and safety regulations at all times.

The product data sheets and material safety data sheets are available on our website www.AQUAPANEL.com/downloads.

Insulation



- › Insulation materials are supplied enclosed in packaging which is designed for short term protection only. For longer term protection on site, the product should be stored either indoors, or under cover and off the ground. Products should not be left permanently exposed to the elements.

INSTALLATION

1. Exterior Stud Frame

The steel framework must be designed according to the static requirements of the construction.

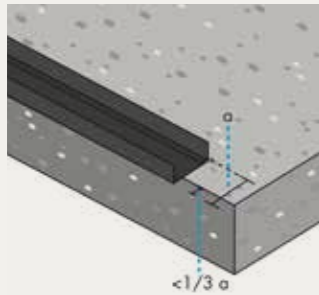

1.1 For an exterior wall, installed between floors, the maximum permissible cantilever of the UW runner is one third of its web height. If the cantilever exceeds this amount, the UW runner has to be supported by a steel angle, installed in front of the floors (here an excess of a maximum cantilever of half of the web height is not allowed). If in this system UW runners with a web height of 100 mm are used, this results in a maximum cantilever of 33.3 mm without the need of additional support.

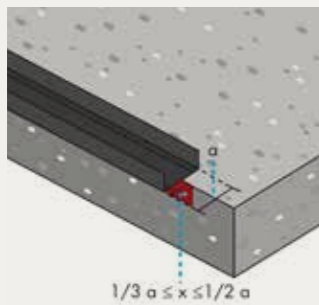

1.2 For the correct alignment of the Knauf Exterior Wall, the vertical alignment of the slab edges of the skeleton construction is measured over all floors. To guarantee straight exterior walls, display the course of the walls on the floors, ceilings and columns before installing the profiles. It is recommended to use a chalk line, a cross-line laser or a rotating laser for these tasks.



1.3 Cut profiles up to 0.7 mm thickness to appropriate length using manual or electrical steel cutter or use an electrical circular saw with special metal blade.

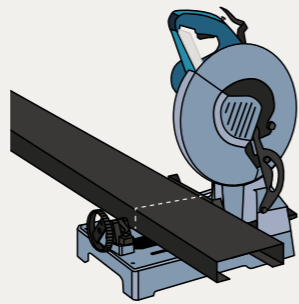

1.4 Metal thicknesses bigger than 0.7 mm cannot be cut by manual steel cutters. Electric separating tools need to be used. The tool has to be selected according to the coating system. This is especially important for lacquers and other organic coatings, which are damaged by the influence of temperature and flying sparks. The use of band saws, low speed chop saws (≤ 1500 rpm) or special circular saws for cold cuts without flying sparks is highly recommended. Cut edges of corrosion-protected profiles with a nominal thickness bigger than 1.5 mm have to be treated with corrosion protection coating (e.g. Drystar-Korrosionsschutzlack C3/C5M).

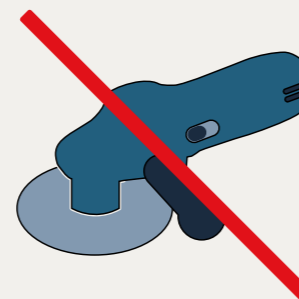

1.5 The use of separation methods causing sparks (e.g. angle grinders) destroy the corrosion protection of the profiles.



1.6 To prevent thermal and acoustic bridges and to compensate uneven surfaces, adhere self-adhesive decoupling tape to the web of the UW runner.

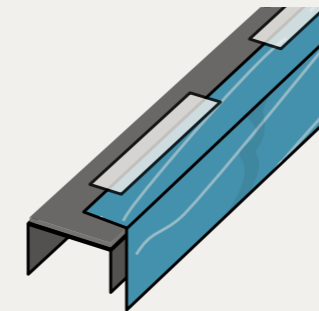

1.7 To guarantee an air-tight connection of the vapour barrier to floors and ceilings, in a first step adhere a 15 cm wide strip of the vapour barrier with an appropriate adhesive tape (e.g. Knauf Insulation LDS Soliplan) on top of the decoupling tape.

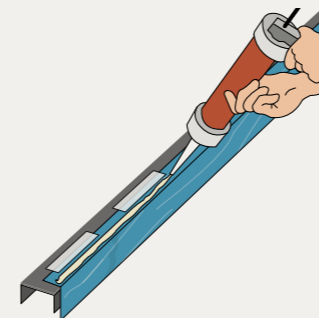

1.8 Secondly apply an appropriate elastic, durably strong pasty adhesive (e.g. Knauf Insulation LDS Solimur) or a double-sided adhesive tape (e.g. Knauf Insulation LDS Kleberaube), before mounting the profiles to the floor and to the ceiling.

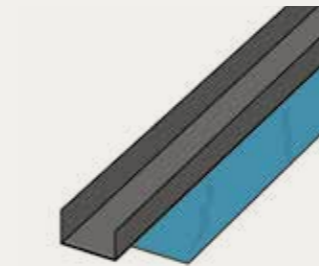

1.9 Use an appropriate drilling machine to drill holes into the reinforced concrete for the anchors.

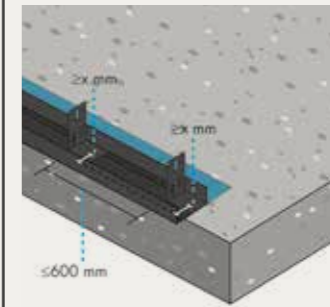

1.10 Mount UW runners at ceilings and floors using approved anchoring means (fasteners and steel angles) according to local building regulations (fire resistance) and static requirements (type and quantity of fasteners). The minimum distance of the fasteners to the floor end depends on the type of fastener used. Do not use plastic plugs due to fire regulations. Please respect the mandatory borehole diameters and depths for the screw anchors used as anchoring means for the vertical profiles.

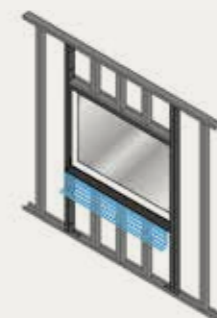

1.11 It is recommended to create the window/door openings first, before installing the studs of the undisturbed parts of the wall, because substantial time savings can be realized. Actually manufacturers can build windows in advance and transport them to the site, because they can work to precise plans and dimensions. So they are ready for immediate installation, while the rest of the studs are set up. The openings and its auxiliary structure have to be designed in accordance with building static requirements.

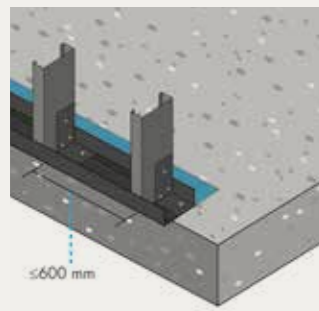

1.12 The distance between the vertical CW studs is dependent on room height and statical calculations (600 mm in maximum), the maximum distance between the first two studs next to other building elements such as walls and columns is half the distance calculated for the undisturbed wall. For instance 300 mm for walls with a stud spacing of 600 mm. Where CW studs are directly connected to these building elements, use decoupling tape. For attaching the CW studs to the steel angles use appropriate connecting elements. The CW studs are cut to length as usual in drywall construction: generally 10 mm shorter than the distance between head and foot point.

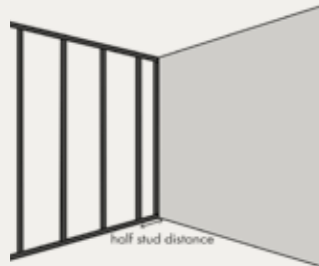

2. Installing the Water Barrier

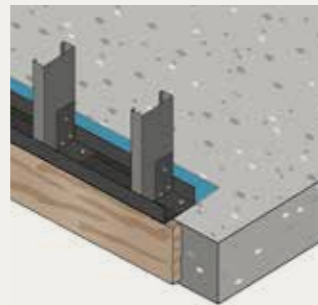

2.1 To prevent thermal bridges at the slab edges insulate the section in front of floors with a layer of glass wool insulation according to building physical requirements, before applying the water barrier. Note: The higher the web heights of the runners and studs, the longer the possible cantilever and the thicker the insulation in front of the floors.

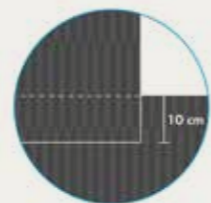
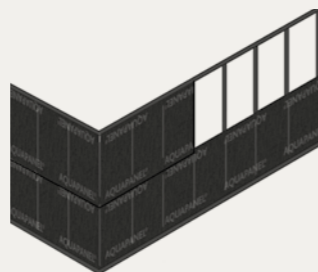
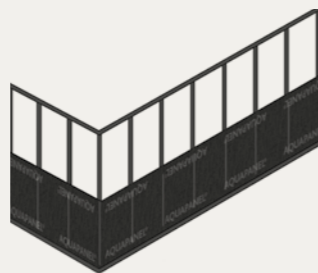

2.2 Before mounting AQUAPANEL® Cement Board Outdoor it is required to install the water and windproof AQUAPANEL® Water Barrier to protect the insulation. Start at the bottom of the wall and install the water barrier horizontally. Secure this foil temporarily by using double-sided adhesive tape, followed by the prompt installation of the boards. Therefore only install as much stretches of the foil, which you are able to cover by boards in one day. Overlap all horizontal and vertical joints of the water barrier at least 10 cm. The horizontal overlap is already marked on the product by two dashed lines. The overlaps themselves do not need to be masked by adhesives.

Option 1: Installing the water barrier onto window openings

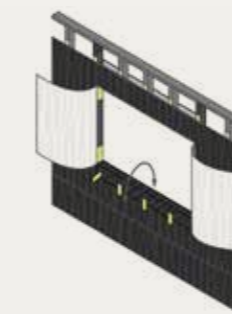

2.3 Approximate to the wall opening from below. If the windows are not installed up to this moment, first cover the lintel area of the opening with a narrow strip of AQUAPANEL® Water Barrier and secure it with adhesive tape. Make sure that the installed strip overlaps at least 10 cm (see exemplary pattern with cut and bent edges).

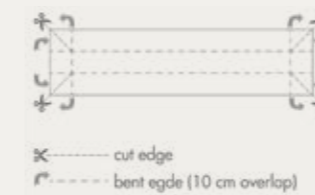

2.4 Cover the opening with one or more stretches of AQUAPANEL® Water Barrier just the same way as for the undisturbed areas of the wall. After that cut the foil horizontally at the lintel and the parapet and vertically in the middle of the window opening and open the resulting protrusions like window shutters to the outside (see picture).

2.5 Like the lintel, also the parapet of the window opening has to be covered with AQUAPANEL® Water Barrier. Therefore again cut a narrow strip of the foil and install it with adhesive tape. Also here the strip has to overlap at least 10 cm (see exemplary pattern with cut and bent edges above).

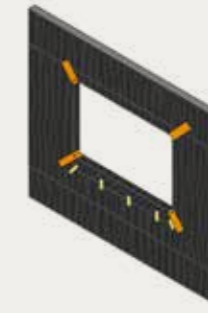
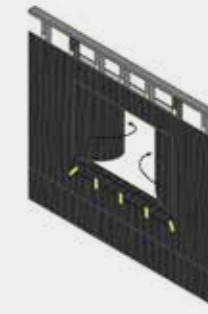

2.6 Fold the protrusions of the AQUAPANEL® Water Barrier inwards and secure it with tape so that it remains properly stretched at the vertical reveals.

2.7 Reinforce window corners with an extra piece of tape, which is adhered directly in the window corners and to some extent pulled over the edges on the outside and inside surface of the wall (e.g. Knauf Insulation LDS Solitwin is particularly suited for this application).

› Option 2: Installing the water barrier over preinstalled windows

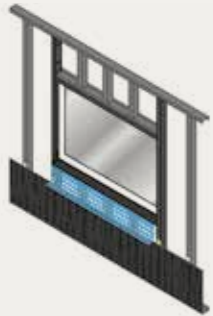

2.3 Approximate to the wall opening from below. If the windows are already installed before the application of the water barrier, just cover the window with one or more stretches of AQUAPANEL® Water Barrier the same way as for the undisturbed areas of the wall.



2.4 Cut out the area of the water barrier, which is covering the window, alongside the reveals, lintel and parapet.



2.5 Fold up the reinforcing mesh underneath the windowsill and secure the water barrier at the parapet with an adhesive tape (e.g. Knauf Insulation LDS Solitop).

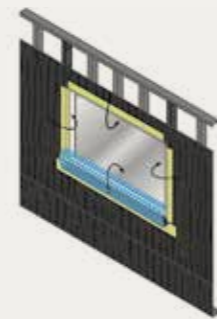
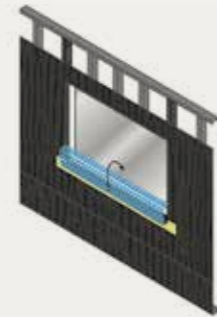

2.6 Finally secure the water barrier lengthwise along the edges of the reveals and the lintel.

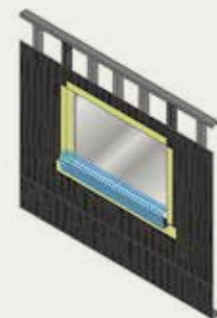

3. Exterior Board Installation



3.1 Mark the desired shape or opening on the board with pencil and ruler. Use a knife to score the cement or gypsum boards on one side along the line so that the mesh resp. thick paper is cut. Snap the scored edge and cut the mesh/paper on the rear side.



3.2 For sharp-edged cuts, for example, exterior edges, use a hand-held circular saw with a dust extractor or a pendulum jigsaw. Use of a carbide or diamond-tipped saw blade is recommended.

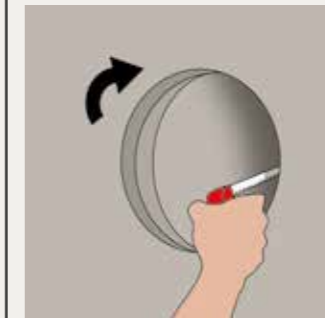

3.3 To make cut-outs for wiring and pipes, use a jigsaw or hole saw. The diameter of the opening should be approximately 10 mm greater than the diameter of the pipe. The remaining gap can be closed with a cuff, suitable sealant or sealing strip.

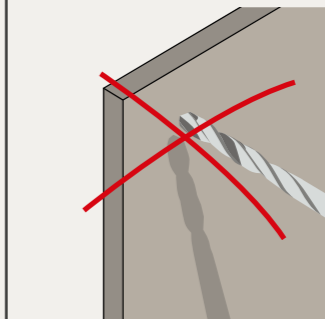
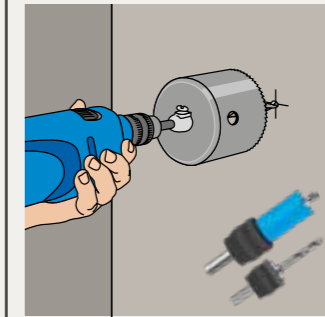

3.4 Generally, no pre-drilling of boards is required. However, pre-drilling of boards and profiles is needed if the material thickness of the profiles exceeds 2 mm (according to static requirements) or when blind rivets are used instead of screws.

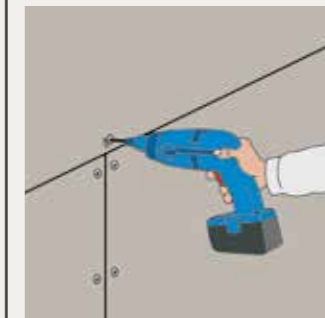

3.5 To fasten the boards with screws use a screw gun with depth stop (comprising overturned sleeve and a stop sleeve). This ensures that all screws are countersunk in the same correct way. Fasten AQUAPANEL® Cement Board Outdoor to the stud frame with AQUAPANEL® Maxi Screws. First fasten the screws in the centre of the cement boards, then work towards the edges. During installation, make sure the cement boards fit closely to the substructure. Screws should not be overtightened.



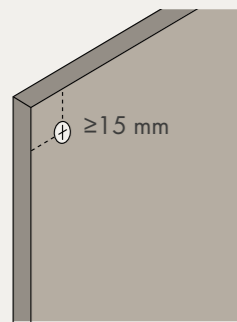

3.6 Follow rules of distances: the screw spacing must not exceed 250 mm and the spacing from the edge has to be at least 15 mm.

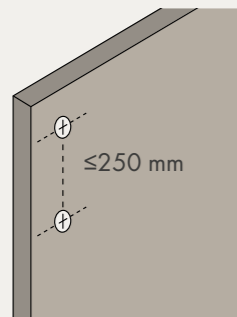

3.7 Apply AQUAPANEL® Cement Board Outdoor panels horizontally. Arrange front edge joints (vertical) on centre of profile flanges. Leave a gap of 3-5 mm between boards alongside the long and front edges (horizontal and vertical) using a suitable spacer. Front edge joints (vertical) must be staggered by at least one stud spacing.

Note: Hairline cracks on the surface of the AQUAPANEL® Cement Board Outdoor are no indications of loss of strength or function, as long as embedded glass fibre mesh is intact.

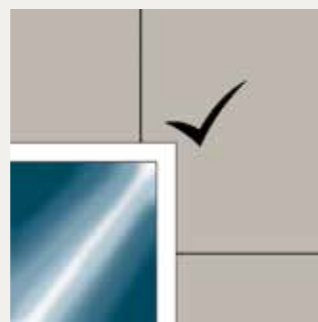

3.8 Take the boards up to the parapet, reveals and parapet of the window or the door. There must be no continuous joints as these could lead to cracks and leaks. The spacing between the board joints and the imaginary extensions (horizontal and vertical) of the window frames has to be at least 150 mm.

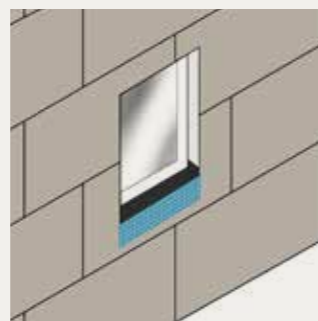
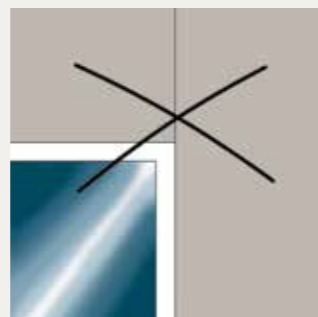

Note: If the windows are already installed, just make sure to fold up the reinforcing mesh underneath the windowsill before fixing AQUAPANEL® Cement Board Outdoor beneath the parapet.

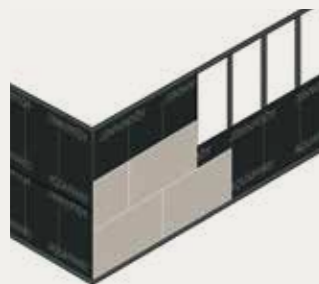
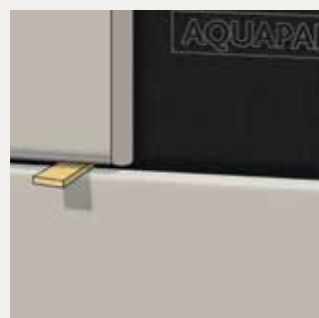
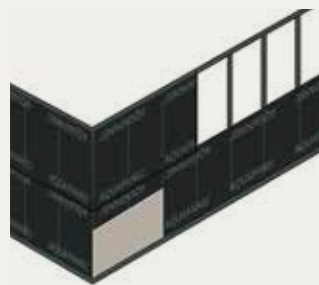

4. Joint Treatment



4.1 Immediately after fixing the boards, protect the wall from weathering by filling all the joints with AQUAPANEL® Joint Filler - grey. Use an agitator to mix the joint filler. A tool with 600 rpm is recommended.

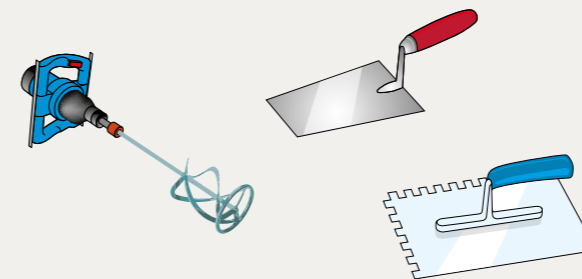

4.2 Right after that embed AQUAPANEL® Tape (10 cm) centred alongside all joints.

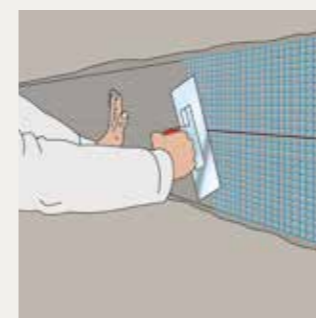

4.3 If later only one coat of paint is to be applied onto AQUAPANEL® Exterior Basecoat or AQUAPANEL® Exterior Basecoat - white, use AQUAPANEL® Exterior Reinforcing Tape which has a width of 20 cm.



4.4 Finally cover the screw heads with AQUAPANEL® Joint Filler - grey.

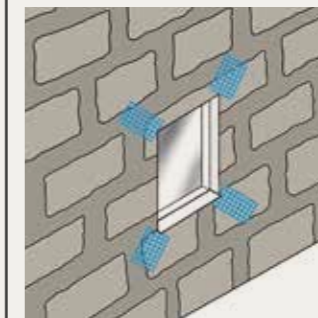

4.5 Reinforce the boards next to the door and window corners with a narrow strip of AQUAPANEL® Reinforcing Mesh (size 50 x 30 cm, applied at an angle of 45° to the corners - see picture).

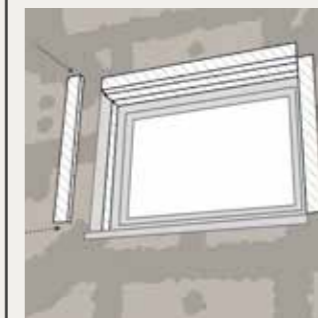

4.6 Mount appropriate PVC-plaster profiles at the corners and edges of the windows to protect them. Embed it in AQUAPANEL® Exterior Basecoat or AQUAPANEL® Joint Filler grey.

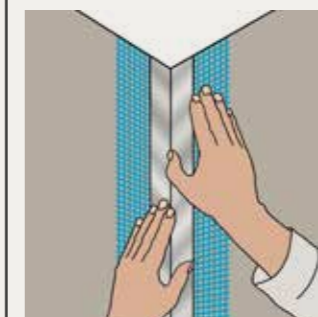

4.7 Outside corners are reinforced by applying a PVC-corner profile with AQUAPANEL® Exterior Basecoat or AQUAPANEL® Joint Filler - grey.

Note: In this state the building envelope is closed. The wall surface may now be freely exposed to the weather for up to six months, before applying render or other finishings. As a result, interior works (including screeding and the installation of stud frames, vapour barrier, lining and insulation) can progress. Before the exterior finishing, the boards only have to be cleaned and dried off.

5. Basecoat and Reinforcing Mesh

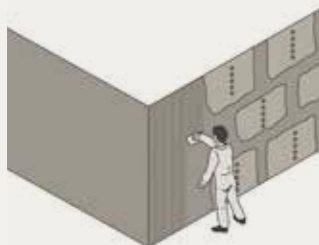

5.1 AQUAPANEL® Cement Board Outdoor must be rendered with AQUAPANEL® Exterior Basecoat or AQUAPANEL® Exterior Basecoat - white, when finishing options are painting, rendering or adhered finishes such as brickslips or tiles. The basecoat is applied by hand using a trowel (use an agitator with 600 rpm to mix) or by machine (machine recommendation: mixing pump PFT G4, rotor/stator D4-3, half power, water requirement 200 l/h).



5.2 When applying the AQUAPANEL® Exterior Basecoat, create a layer of average 5 mm thickness using a notched trowel of 10 x 10 mm.

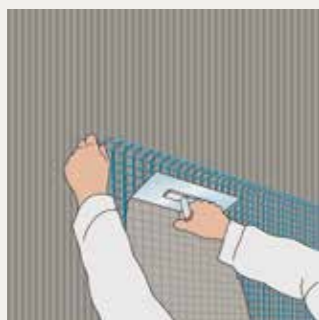

5.3 Gently embed/place the mesh. Overlap all joints of the mesh at least 10 cm.

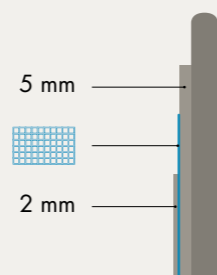
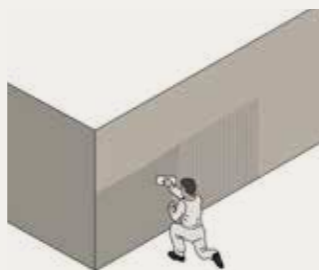

5.4 On top of the mesh add an extra 2 mm basecoat layer with a smooth trowel to close the surface and to eliminate unevenness. Total thickness of the mesh-reinforced basecoat should be 5-7 mm. When these steps are completed, the mesh lies in the first third of the basecoat. Before continuing with the next steps, allow a curing time of 1 day per mm of layer thickness.* Protect fresh basecoat from the effects of frost, rapid drying and weathering.

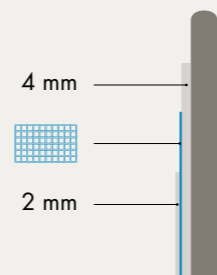

Note: With AQUAPANEL® Exterior Basecoat - white, it is best to create a layer of 4 mm thickness and using a trowel with 8 x 8 mm notches, before embedding the mesh. On top of the mesh add an extra 2 mm basecoat layer with a smooth trowel, as described in point 5.4. Allow a curing time of 1 day* for the full layer thickness and protect fresh basecoat from the effects of frost, rapid drying and weathering, before continuing with the next steps.

*All time specifications given here are depending on climate conditions.

6. Exterior Finishing

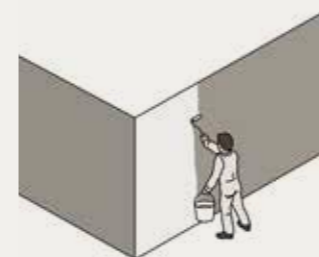

6.1 Apply AQUAPANEL® Basecoat Primer before applying the AQUAPANEL® finishing renders: AQUAPANEL® Exterior Silicon Synthetic Resin Plaster - white, AQUAPANEL® Exterior Dispersion Plaster - white, AQUAPANEL® Exterior Mineral Finish. Wait at least 24 hours before applying the finishing render, to ensure the primer is fully dried. If you want to apply paint as finishing, AQUAPANEL® Basecoat Primer is not necessary.



6.2 On the primed surface, finishing render is applied by hand using a trowel (use an agitator with 600 rpm to mix). Machine processing is possible when using AQUAPANEL® Exterior Mineral Finish (machine recommendation: mixing pump PFT G4, rotor/stator D4-3, half power, water requirement 200 l/h). Apply with a stainless smoothing trowel according to grain size, and then with a designated tool (foam rubber and sponge disk, PVC trowel, brush) according to the desired structure. Protect fresh render from the effects of frost, rapid drying and weathering.

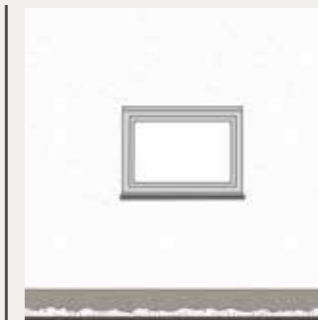
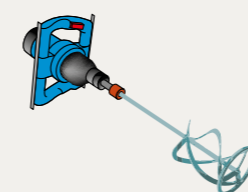

6.3 If scaffolding anchors are present, pass them through the AQUAPANEL® Cement Board Outdoor and close the remaining holes with plastic plugs when dismantling the scaffold.

Note: If you want to adhere finishing materials such as clinker bricks, glass elements or tiles, make sure to glue them in frost-free conditions using a frost-proof process. Keep the adhesive layer free from voids. Select suitable adhesives according to manufacturers' recommendations for cement bases.

For thin clinker brick and tile applications, the maximum permitted load of tiling including adhesive is 40 kg per square metre. The max. dimensions are limited to ≤ 0.12m² surface and ≤ 0.40m edge length. Contact your local Knauf staff if the load or dimensions are higher.

7. Insulation of the Exterior Stud Frame



7.1 At first the exterior stud frame has to be insulated. Use the right product for the job depending on whether thermal insulation, acoustic insulation or fire protection is required. Insulation materials are easy to handle and install, being lightweight and easily cut to size. Where necessary, use an appropriate knife on flat surface to cut.



7.2 To minimise thermal bridges insulation should fill the complete stud spaces. Do not use small pieces.

8. Interior Lining

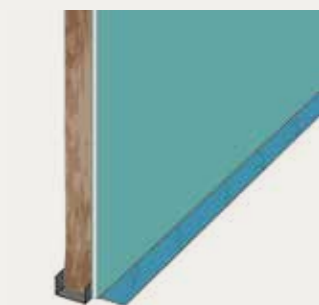

8.1 After filling the stud frame completely with insulation material, install the first layer of gypsum boards (GKBI). Place the panel edges in the middle of the stud flanges.



8.2 Fix the gypsum boards with appropriate screws (e.g. Schnellbauschraube TN 3.5x25) to the substructure. Penetration of the metal substructure has to be at least 10 mm. The screw spacing must not exceed 750 mm (board width: 1250 mm in a vertical board positioning) resp. 600 mm (board width: 625 mm in horizontal board positioning) and the spacing from the edge has to be at least 10 mm (half-rounded tapered edges) resp. 15 mm (cut edges).

Note: At this stage protection against falling is ensured and the scaffold on the exterior can be dismantled.

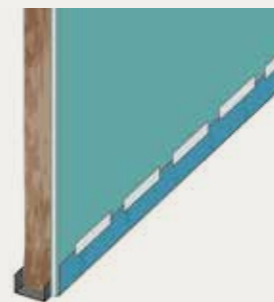

8.3 Fix the free end of the 15 cm wide vapour barrier strip onto the first layer of gypsum boards with an appropriate adhesive tape.

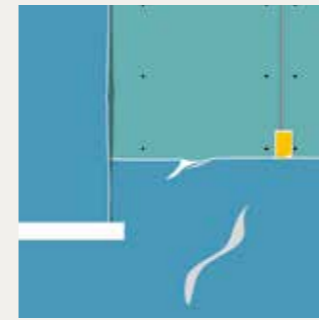

8.4 Install the Knauf Insulation LDS 10 Silk vapour barrier over the entire surface. The vapour barrier must overlap where more than one sheet is placed. Overlaps, window connections and pipe and service penetrations have to be sealed with appropriate adhesion tapes (e.g. Knauf Insulation LDS Soliplan, Solitwin or Solifit S) in order to obtain optimum air tightness. Mount gypsum boards (GKBI) in front of the vapour barrier. Work in staggered method; stagger at least one stud space.

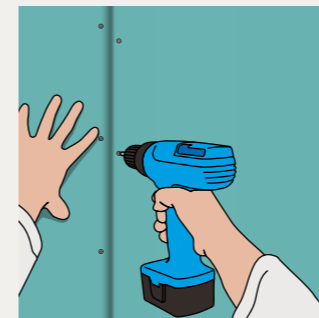

8.5 To fix the boards to the substructure use an appropriate drywall screw (e.g. Schnellbauschraube TN Feingewinde 3.5x35). Penetration of the metal substructure has to be at least 10 mm. The screw spacing must not exceed 250 mm (board width: 1,250 mm in vertical board positioning) resp. 200 mm (board width: 625 mm in horizontal board positioning) and the spacing from the edge has to be at least 10 mm (half-rounded tapered edges) resp. 15 mm (cut edges).



8.6 Fill joints fully (e.g. standard gypsum board application with half-rounded tapered edges). Use trowel to fill joints with suitable joint filler (e.g. Uniflott).

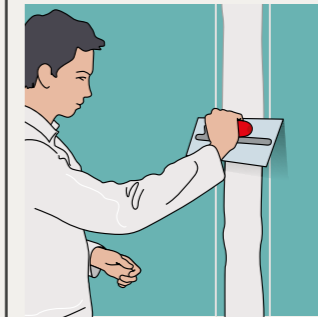

8.7 Run the trowel progressively down the joint applying sufficient pressure to squeeze out entrapped air. Allow the joint filler to set for approx. 1 hour. If required, sand lightly to remove any high spots. Remove surface dust.

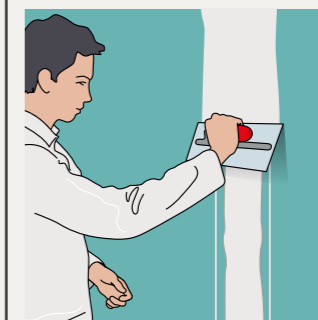

8.8 Apply an additional thin layer of joint filler and remove any surplus filler. Create a smooth and levelled transition to the board surface with Trowel or Wide Spatula. Feather out application beyond the joints – approximately 100 to 200 mm.



8.9 Allow the joint filler to set for approx. 1 hour. If required, sand lightly to remove any high spots. Remove surface dust.

9. Interior Finishing

For detailed information about interior finishing options, please contact your local Knauf organisation.

MATERIAL CONSUMPTION & ERECTION TIME

Product Group	Materials (from the inside to the outside)	Thickness (mm)	Weight per m ² (kg)	Material consumption per m ²	Unit	Installation time per m ² (min)
Stud framework (600 mm stud spacing)	Knauf Wallboard impregnated (GKBI/H2) or similar	12.50	10.00	1	m ²	55
	Knauf Drywall Screw	-	-	15	pcs.	
	Knauf Uniflott or similar	-	0.40	0.4	kg	
	Knauf Trennfix or similar	-	-	0.9	m	
	Knauf Insulation LDS 10 silk or similar	-	-	1.1	m ²	
	Knauf Insulation LDS adhesive tape	-	-	1	pcs.	
	Knauf Wallboard impregnated (GKBI/H2) or similar	12.50	10.00	1	m ²	
	CW 100/50/06 (minimum corrosion protection C3)	-	1.80	2	linear m	
	UW 100/50/06 (minimum corrosion protection C3)	-	0.63	0.7	linear m	
	Knauf Dichtungsband 95 mm	-	-	0.7	linear m	
	Anchoring means (to be provided on site)	-	-	3	pcs.	
	Steel angles (to be provided on site)	-	-	1.5	pcs.	
	Connection means (to be provided on site)	-	-	4.5	pcs.	
	Insulation board according to local needs	100.00	1.60	1	m ²	
Water barrier / windproofing	AQUAPANEL® Water Barrier	-	-	1.1	m ²	2
	Adhesive tape	-	-	1	pcs.	
Exterior lining	AQUAPANEL® Cement Board Outdoor	12.50	16.00	1	m ²	15
	AQUAPANEL® Maxi Screw SN25	-	-	15	pcs.	
	AQUAPANEL® Joint Tape (10cm)	-	-	2.1	linear m	
	AQUAPANEL® Joint Filler - grey	-	0.70	0.7	kg	
Render (w/o finishing plaster)	AQUAPANEL® Exterior Basecoat - white	5.00	6.30	6.3	kg	10
	AQUAPANEL® Reinforcing Mesh	-	-	1.1	m ²	
Sum		142.50	46.89			82

BENEFIT FROM THE VALUABLE SERVICES FROM AQUAPANEL®



AQUAPANEL® WEBSITE

Discover a world of online resources and support available 24/7 to help you understand and communicate the full scope of the AQUAPANEL® family. Find and download in-depth technical documents, films and the latest materials, always up to date.

› www.aquapanel.com



INTERNATIONAL TRAINING CENTRE

Stay in the loop and keep your knowledge at the cutting edge with professional, practical seminars from the AQUAPANEL® International Training Centre. With courses designed to give you and your people fresh insights and understanding you get a unique advantage. For more information, please contact your local AQUAPANEL® partner or email us:

› aquapanel.info@knauf.com



YOUTUBE CHANNEL

See AQUAPANEL® in action. Our YouTube channel features product introductions and how-to videos on everything from installation to finishing options and curved wall constructions. It's all available any time – and we'll be regularly updating the channel with our latest videos, making it the first place to go for new AQUAPANEL® content.

› www.youtube.com
Search: Knauf Aquapanel

All technical changes reserved. Only the current printed instructions are valid. Our warranty is expressly limited to our products in flawless condition. The constructional and structural properties and characteristic building physics of Knauf systems can solely be ensured with the exclusive use of Knauf system components, or other products expressly recommended by Knauf. All application quantities and delivery amounts are based on empirical data that are not easily transferable to other deviating areas. All rights reserved. All amendments, reprints and photocopies, including those of excerpts, require the express permission of Knauf Aquapanel GmbH & Co. KG, Zur Helle 11, 58638 Iserlohn, Germany. AQUAPANEL® is a registered trademark.