



WM111C.2

Single Stud, KEW Profile, ETICS



Modelling render

Groove render



## WM111C.2

Single stud, KEW profile, ETICS

With the addition of an extra 80 mm thick layer of insulation to the system WM111C.2 by attaching an external thermal insulation composite system (ETICS) with an adhesive mortar directly on the AQUAPANEL® Cement Board Outdoor, an excellent thermal performance of 0.211 W/(m<sup>2</sup>K) can be achieved. Various desired U-values can be met by changing the thickness of the insulation. Those mineral wool insulation panels are non-combustible, and as such comply with highest levels of fire protection, guarantee an optimum room climate and additional sound insulation. Even additional fastenings with anchors may be waived depending on wind loads.



Broom finish



Floated render



## CONTENTS

Axonometry	4
Static features and physical properties	5
Economic advantages	6
Construction drawings	16
Sample specifications	25
Product range	32
Product handling and installation	41
Material consumption and erection time	52



**Axonometry**

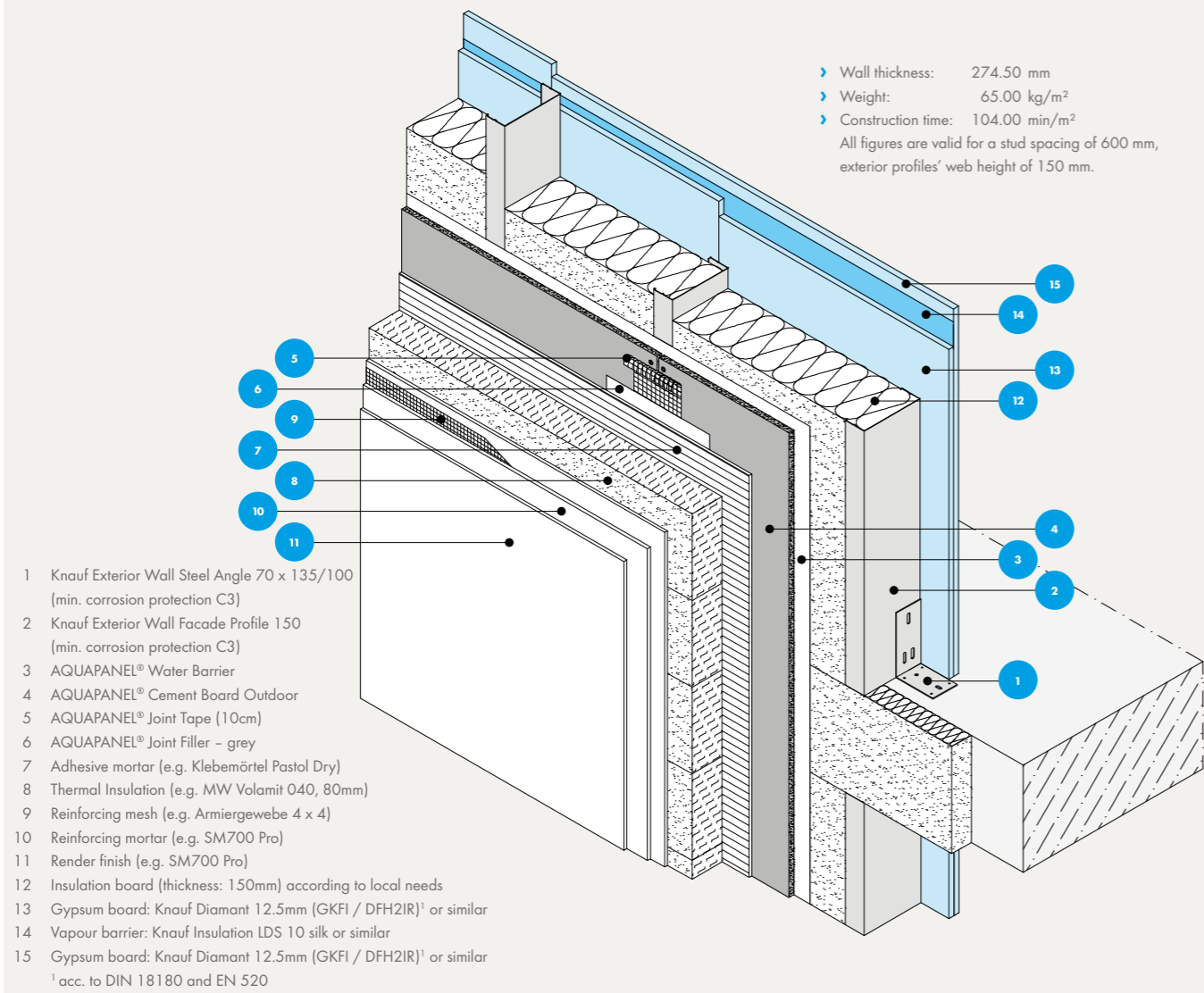

**Characteristics of the construction**

- > The exterior stud frame, with the KEW Profile 150 serves as weather protection and the load transfer of wind- and dead-load into the primary construction.
- > Building physics suitable for residential and non-residential buildings (≥19°C), e. g. residential buildings, office buildings, hotels, hospitals, schools, etc.
- > The ETIC System (Knauf Warm-Wand System) is to be glued to the AQUAPANEL® Cement Board Outdoor.

**Particularities for the assembly**

- > An appropriate corrosion protection is to be considered, at least C3 according to EN ISO 12944.
- > The KEW Profile 150 has to be fixed to the load-bearing structure using the KEW Steel Angel 70x135/100 and the KEW Screws 4,8x20; use appropriate anchors, e. g. concrete screws or bolt anchors acc. to the static calculation.
- > The exterior stud-frame is built without UW runner. The alignment of the Profiles is done with the positioning of the KEW Steel Angle 70x135/100.
- > The stud frame can be used as installation area. Consider, that the connection between penetrations and vapour barrier have to be vapour-tight.
- > The ETIC System (Knauf Warm-Wand System) is to be glued to the AQUAPANEL® Cement Board Outdoor.

**Preliminary design acc. to EN 1993-1-3 for Knauf Exterior Wall Profile 150**

Wind load $w_e$ (kN/m <sup>2</sup> )	span (m); wall heights								
	2.4	2.6	2.8	3.0	3.2	3.4	3.6	3.8	4.0
0.4									
0.5									
0.6									
0.7									
0.8									
0.9									
1.0									
1.1									
1.2									
1.3									
1.4									
1.5									
1.6									
1.7									
1.8									
1.9									
2.0									
2.1									
2.2									
2.3									
2.4									
2.5									
2.6									
2.7									

Span table is used to show how the substructure needs to be dimensioned as a function of wind loads [kN/m<sup>2</sup>] according to national standards and the span widths of the profiles, which are determined (usually synonymous with floor height).

The substructure shown in the table comprises a combination of the KEW profile 150, fixed to the KEW steel angle 70x135/100 with a KEW screw.

Please note: the table provides an indication for preliminary design purposes only. This must be subsequently verified by an object-related structural calculation, following the relevant local norms and guidelines. The choice of anchors to transfer the loads into the primary structure should only be made on the basis of this project-specific structural design.

- 600 mm stud spacing
- 400 mm stud spacing
- On request







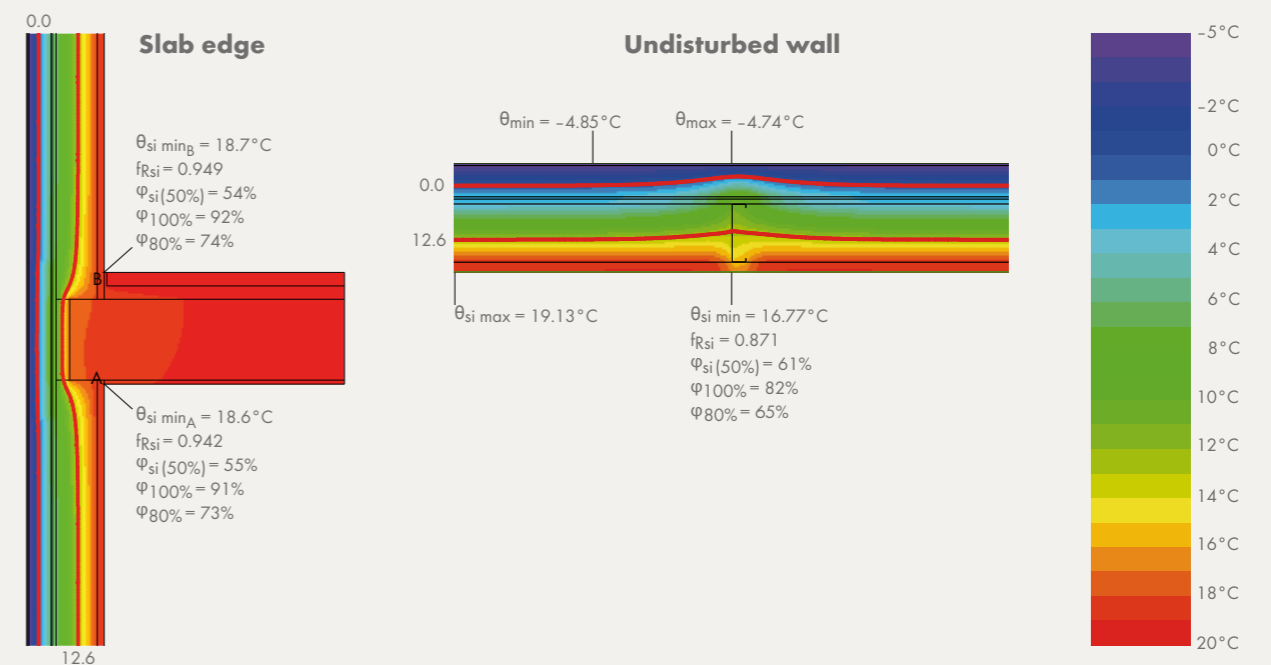

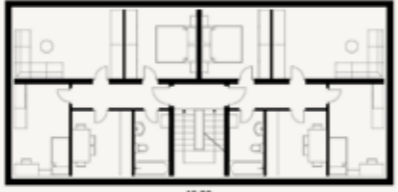
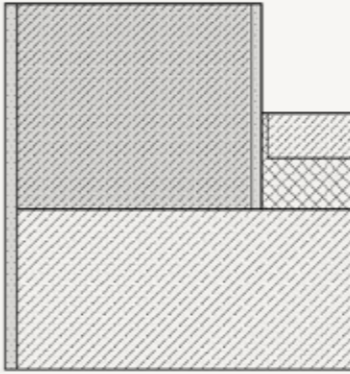
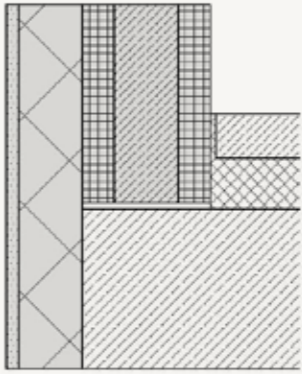
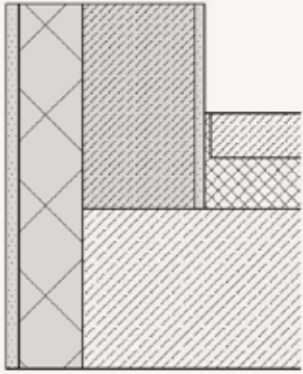

**Building-physical features**

Heat transition coefficient* $U_w = U_0 + U_{WB, Profile}$ (undisturbed wall, metal profiles are taken into account) - [W/m <sup>2</sup> K]	0.211
Thermal bridge heat transfer at slab edge (linear thermal transmittance) Psi-value/ $\Psi$ -value - [W/mK]	0.028
Sound reduction index $R_w^*$ - [dB]	56**
Fire performance (i ↔ o)	EI30

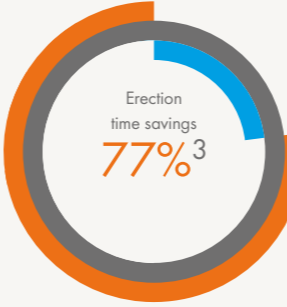
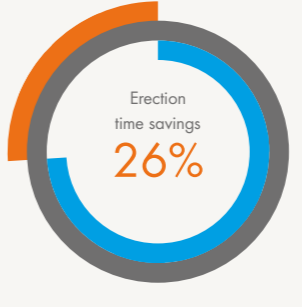
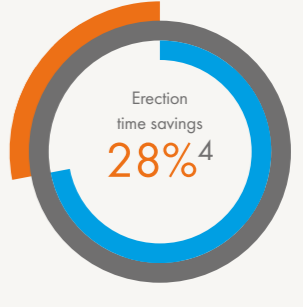
**Temperature fields and isotherms\***



\*Valid for a stud spacing of 600 mm \*\*Calculated with INSUL (v9.0.1)

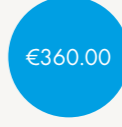





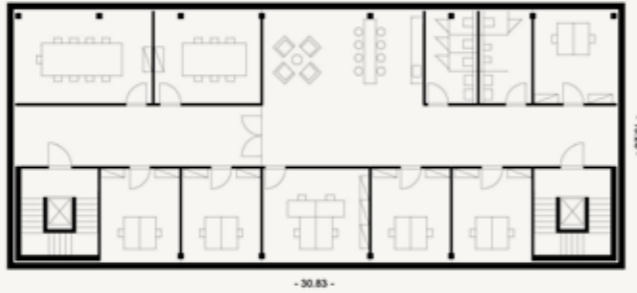
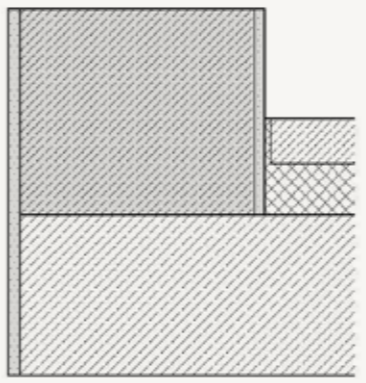
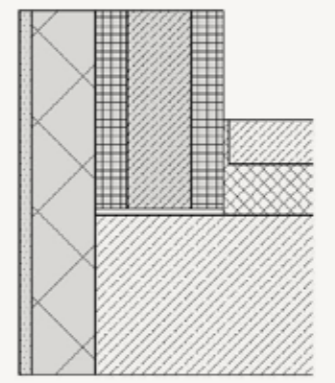
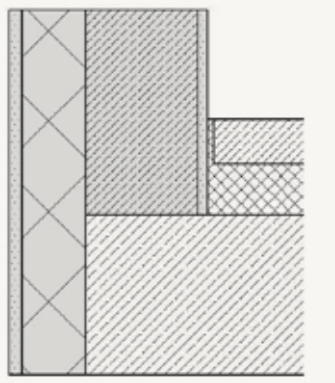

Economic advantages (example: floor extension)		compared with ...	Aerated concrete	Precast concrete parts + ETICS	Sand lime bricks + ETICS
Building perimeter (m): 58 m Floor height: 3 m Exterior wall surface per floor: 174 m <sup>2</sup> Number of floors: 1 Wall opening share: 25% Opening surface: 43.50 m <sup>2</sup> Net exterior wall surface: 130.50 m <sup>2</sup>					
Cost-influencing factors <sup>1</sup>		compared with ...	Aerated concrete	Precast concrete parts + ETICS	Sand lime bricks + ETICS
<b>Weight</b>	<p>Based on a specific intended use and location of a building, the dead weight is the most important factor of the total loads, which can be influenced by planning. Basically, lower loads enable a leaner structure and thus significant cost savings.</p> <p>The calculation of explicit cost saving amounts for load-bearing walls and ceilings as well as foundations achieved by the weight reduction when using the Knauf Exterior Wall is generically not possible, since this is always to be calculated projectspecifically on the basis of floor plan geometries, spans and the load-bearing capacity of the building ground.</p>		 <p>Weight savings <b>56%</b></p> <p>11 tons WM111C.2 26 tons Aerated concrete 15 tons Weight savings</p>	 <p>Weight savings <b>83%</b></p> <p>11 tons WM111C.2 67 tons Precast concrete parts + ETICS 55 tons Weight savings</p>	 <p>Weight savings <b>66%</b></p> <p>11 tons WM111C.2 33 tons Sand lime bricks + ETICS 22 tons Weight savings</p>
<b>Erection time</b>	<p>With a longer production time considerable costs for the personnel employment are connected, additionally a longer building process means a longer supply of building site facilities, whose costs should be minimised. The efficient construction of the Knauf Exterior Wall as well as the shorter drying times and the significantly lower weather dependency compared to massive constructions offer a considerable cost reduction potential and entail much less risk in the planning of the construction process.</p> <p>Additionally, if in masonry constructions, such as aerated concrete or sand-lime brick, the windows are not installed in the insulation layer, the openings must first be measured after erection of the exterior wall. Whereas with the Knauf Exterior Wall, manufacturers can work to precise plans and dimensions and therefore build windows in advance and transport them to the site, ready for immediate installation. A further advantage, which brings considerable time savings.</p>		 <p>Erection time savings <b>77%</b><sup>3</sup></p> <p>14 days WM111C.2 58 days Aerated concrete 45 days Erection time savings</p>	 <p>Erection time savings <b>26%</b></p> <p>14 days WM111C.2 19 days Precast concrete parts + ETICS 5 days Erection time savings</p>	 <p>Erection time savings <b>28%</b><sup>4</sup></p> <p>14 days WM111C.2 19 days Sand lime bricks + ETICS 5 days Erection time savings</p>
Revenue-influencing factors <sup>1</sup>		compared to ...	Aerated concrete	Precast concrete parts + ETICS	Sand lime bricks + ETICS
<b>Space</b>	<p>By using the Knauf Exterior Wall more space can be realised inside the building with a comparable thermal insulation value. Consequently, rentable space and resulting rental income are larger. For landlords and investors, the best possible use of the land area plays an important role. By using the Knauf Exterior Wall, this area efficiency and land utilisation are significantly improved.</p>		 <p>7.52 m<sup>2</sup> Space gain when using WM111C.2 compared to aerated concrete</p>	 <p>4.61 m<sup>2</sup> Space gain when using WM111C.2 compared to precast concrete parts + ETICS</p>	 <p>3.00 m<sup>2</sup> Space gain when using WM111C.2 compared to sand lime bricks + ETICS</p>
<b>Rental income</b>			 <p>€902.40 Additional income through rental (in €/year)<sup>2</sup></p>	 <p>€553.20 Additional income through rental (in €/year)<sup>2</sup></p>	 <p>€360.00 Additional income through rental (in €/year)<sup>2</sup></p>

<sup>1</sup>Figures are based on a study by Prof. Dr. Bert Bielefeld of the University of Siegen, Germany. All measurements use comparable U-values.

<sup>2</sup>Rental income based (in €/m<sup>2</sup> per month): 10.00€

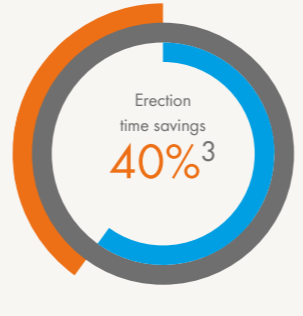
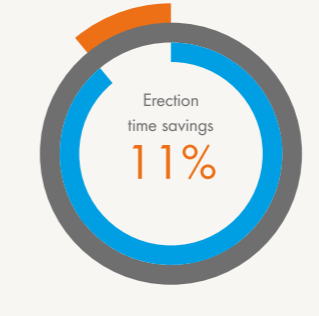
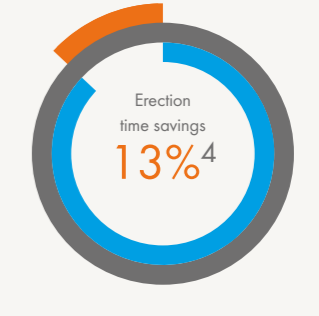
<sup>3</sup>The time saved due to immediate window installation is taken into account.

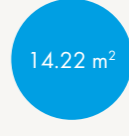
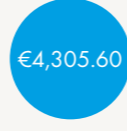
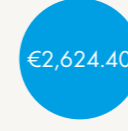
<sup>4</sup>If the windows are not installed in the insulation layer, the erection time savings increase to 47.3 days or 78%.

Economic advantages (example: office building)		compared with ...	Aerated concrete	Precast concrete parts + ETICS	Sand lime bricks + ETICS
<p>Building perimeter (m): 88.1 m</p> <p>Floor height: 3.5 m</p> <p>Exterior wall surface per floor: 308.35 m<sup>2</sup></p> <p>Number of floors: 3</p> <p>Wall opening share: 33%</p> <p>Opening surface: 305.26 m<sup>2</sup></p> <p>Net exterior wall surface: 619.78 m<sup>2</sup></p> 					
Cost-influencing factors <sup>1</sup>		compared with ...	Aerated concrete	Precast concrete parts + ETICS	Sand lime bricks + ETICS
<b>Weight</b>	<p>Based on a specific intended use and location of a building, the dead weight is the most important factor of the total loads, which can be influenced by planning. Basically, lower loads enable a leaner structure and thus significant cost savings.</p> <p>The calculation of explicit cost saving amounts for load-bearing walls and ceilings as well as foundations achieved by the weight reduction when using the Knauf Exterior Wall is generically not possible, since this is always to be calculated projectspecifically on the basis of floor plan geometries, spans and the load-bearing capacity of the building ground.</p>		 <p>Weight savings <b>56%</b></p> <p>54 tons WM111C.2 123 tons Aerated concrete 69 tons Weight savings</p>	 <p>Weight savings <b>83%</b></p> <p>54 tons WM111C.2 316 tons Precast concrete parts + ETICS 262 tons Weight savings</p>	 <p>Weight savings <b>66%</b></p> <p>54 tons WM111C.2 159 tons Sand lime bricks + ETICS 105 tons Weight savings</p>
<b>Erection time</b>	<p>With a longer production time considerable costs for the personnel employment are connected, additionally a longer building process means a longer supply of building site facilities, whose costs should be minimised. The efficient construction of the Knauf Exterior Wall as well as the shorter drying times and the significantly lower weather dependency compared to massive constructions offer a considerable cost reduction potential and entail much less risk in the planning of the construction process.</p> <p>Additionally, if in masonry constructions, such as aerated concrete or sand-lime brick, the windows are not installed in the insulation layer, the openings must first be measured after erection of the exterior wall. Whereas with the Knauf Exterior Wall, manufacturers can work to precise plans and dimensions and therefore build windows in advance and transport them to the site, ready for immediate installation. A further advantage, which brings considerable time savings.</p>		 <p>Erection time savings <b>40%<sup>3</sup></b></p> <p>57 days WM111C.2 95 days Aerated concrete 39 days Erection time savings</p>	 <p>Erection time savings <b>11%</b></p> <p>57 days WM111C.2 64 days Precast concrete parts + ETICS 7 days Erection time savings</p>	 <p>Erection time savings <b>13%<sup>4</sup></b></p> <p>57 days WM111C.2 65 days Sand lime bricks + ETICS 9 days Erection time savings</p>
Revenue-influencing factors <sup>1</sup>		compared to ...	Aerated concrete	Precast concrete parts + ETICS	Sand lime bricks + ETICS
<b>Space</b>	<p>By using the Knauf Exterior Wall more space can be realised inside the building with a comparable thermal insulation value. Consequently, rentable space and resulting rental income are larger. For landlords and investors, the best possible use of the land area plays an important role. By using the Knauf Exterior Wall, this area efficiency and land utilisation are significantly improved.</p>		 <p>35.88 m<sup>2</sup> Space gain when using WM111C.2 compared to aerated concrete</p>	 <p>21.87 m<sup>2</sup> Space gain when using WM111C.2 compared to precast concrete parts + ETICS</p>	 <p>14.22 m<sup>2</sup> Space gain when using WM111C.2 compared to sand lime bricks + ETICS</p>
<b>Rental income</b>			 <p>€4,305.60 Additional income through rental (in €/year)<sup>2</sup></p>	 <p>€2,624.40 Additional income through rental (in €/year)<sup>2</sup></p>	 <p>€1,706.40 Additional income through rental (in €/year)<sup>2</sup></p>

<sup>1</sup>Figures are based on a study by Prof. Dr. Bert Bielefeld of the University of Siegen, Germany. All measurements use comparable U-values.

<sup>2</sup>Rental income based (in €/m<sup>2</sup> per month): 10.00€

<sup>3</sup>The time saved due to immediate window installation is taken into account.

<sup>4</sup>If the windows are not installed in the insulation layer, there are erection time savings of 50.6 days or 47%.



Economic advantages (example: high-rise residential building)		compared with ...	Aerated concrete	Precast concrete parts + ETICS	Sand lime bricks + ETICS
<p>Building perimeter (m): 144 m</p> <p>Floor height: 3 m</p> <p>Exterior wall surface per floor: 432 m<sup>2</sup></p> <p>Number of floors: 9</p> <p>Wall opening share: 25%</p> <p>Opening surface: 972 m<sup>2</sup></p> <p>Net exterior wall surface: 2,916 m<sup>2</sup></p>	<p>▶ Only one third of the building is shown. ▶ Assumption: 3 living units per floor at 240.83m<sup>3</sup> incl. hallway.</p>				
Cost-influencing factors <sup>1</sup>		compared with ...	Aerated concrete	Precast concrete parts + ETICS	Sand lime bricks + ETICS
<b>Weight</b>	<p>Based on a specific intended use and location of a building, the dead weight is the most important factor of the total loads, which can be influenced by planning. Basically, lower loads enable a leaner structure and thus significant cost savings.</p> <p>The calculation of explicit cost saving amounts for load-bearing walls and ceilings as well as foundations achieved by the weight reduction when using the Knauf Exterior Wall is generically not possible, since this is always to be calculated projectspecifically on the basis of floor plan geometries, spans and the load-bearing capacity of the building ground.</p>		<p>Weight savings <b>56%</b></p> <p>254 tons WM111C.2 579 tons Aerated concrete 325 tons Weight savings</p>	<p>Weight savings <b>83%</b></p> <p>254 tons WM111C.2 1,488 tons Precast concrete parts + ETICS 1,235 tons Weight savings</p>	<p>Weight savings <b>66%</b></p> <p>254 tons WM111C.2 748 tons Sand lime bricks + ETICS 495 tons Weight savings</p>
<b>Erection time</b>	<p>With a longer production time considerable costs for the personnel employment are connected, additionally a longer building process means a longer supply of building site facilities, whose costs should be minimised. The efficient construction of the Knauf Exterior Wall as well as the shorter drying times and the significantly lower weather dependency compared to massive constructions offer a considerable cost reduction potential and entail much less risk in the planning of the construction process.</p> <p>Additionally, if in masonry constructions, such as aerated concrete or sand-lime brick, the windows are not installed in the insulation layer, the openings must first be measured after erection of the exterior wall. Whereas with the Knauf Exterior Wall, manufacturers can work to precise plans and dimensions and therefore build windows in advance and transport them to the site, ready for immediate installation. A further advantage, which brings considerable time savings.</p>		<p>Erection time savings <b>0%</b><sup>3</sup></p> <p>254 days WM111C.2 254 days Aerated concrete 0 days Erection time savings</p>	<p>Erection time savings <b>2%</b></p> <p>254 days WM111C.2 260 days Precast concrete parts + ETICS 6 days Erection time savings</p>	<p>Erection time savings <b>5%</b><sup>4</sup></p> <p>254 days WM111C.2 268 days Sand lime bricks + ETICS 14 days Erection time savings</p>
Revenue-influencing factors <sup>1</sup>		compared to ...	Aerated concrete	Precast concrete parts + ETICS	Sand lime bricks + ETICS
<b>Space</b>	<p>By using the Knauf Exterior Wall more space can be realised inside the building with a comparable thermal insulation value. Consequently, rentable space and resulting rental income are larger. For landlords and investors, the best possible use of the land area plays an important role. By using the Knauf Exterior Wall, this area efficiency and land utilisation are significantly improved.</p>		<p>Space gain when using WM111C.2 compared to aerated concrete <b>177.93 m<sup>2</sup></b></p>	<p>Space gain when using WM111C.2 compared to precast concrete parts + ETICS <b>108.81 m<sup>2</sup></b></p>	<p>Space gain when using WM111C.2 compared to sand lime bricks + ETICS <b>71.01 m<sup>2</sup></b></p>
<b>Rental income</b>			<p>Additional income through rental (in €/year)<sup>2</sup> <b>€21,351.60</b></p>	<p>Additional income through rental (in €/year)<sup>2</sup> <b>€13,057.20</b></p>	<p>Additional income through rental (in €/year)<sup>2</sup> <b>€8,521.20</b></p>

<sup>1</sup>Figures are based on a study by Prof. Dr. Bert Bielefeld of the University of Siegen, Germany. All measurements use comparable U-values.

<sup>2</sup>Rental income based (in €/m<sup>2</sup> per month): 10.00€

<sup>3</sup>The time saved due to immediate window installation is taken into account.



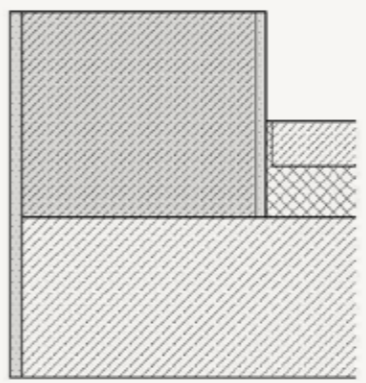
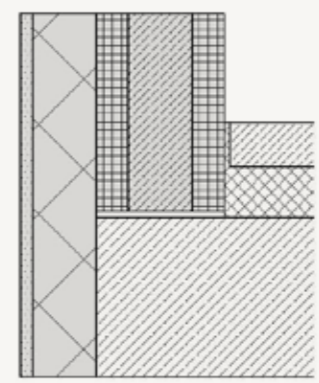
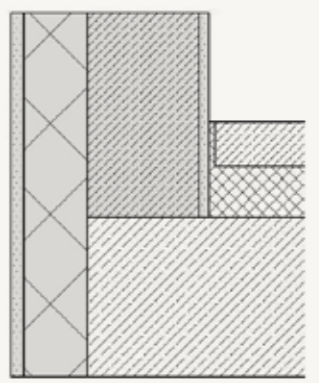







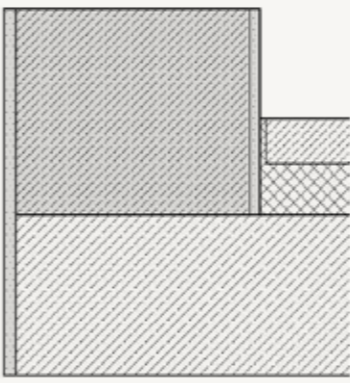
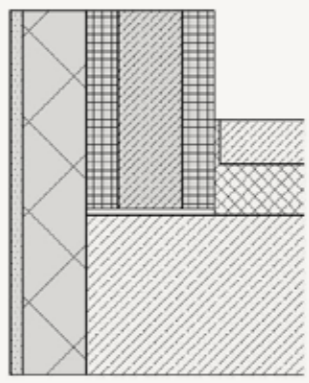
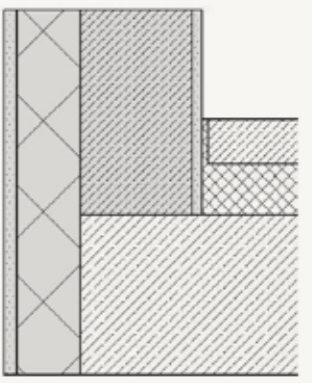

<sup>4</sup>If the windows are not installed in the insulation layer, the erection time savings increase to 55.8 days or 18%.

Economic advantages (example: hospital extension)		compared with ...	Aerated concrete	Precast concrete parts + ETICS	Sand lime bricks + ETICS
<p>Building perimeter (m): 61 m</p> <p>Floor height: 4 m</p> <p>Exterior wall surface per floor: 244 m<sup>2</sup></p> <p>Number of floors: 2</p> <p>Wall opening share: 25%</p> <p>Opening surface: 122 m<sup>2</sup></p> <p>Net exterior wall surface: 366 m<sup>2</sup></p>					
Cost-influencing factors <sup>1</sup>		compared with ...	Aerated concrete	Precast concrete parts + ETICS	Sand lime bricks + ETICS
<b>Weight</b>	<p>Based on a specific intended use and location of a building, the dead weight is the most important factor of the total loads, which can be influenced by planning. Basically, lower loads enable a leaner structure and thus significant cost savings.</p> <p>The calculation of explicit cost saving amounts for load-bearing walls and ceilings as well as foundations achieved by the weight reduction when using the Knauf Exterior Wall is generically not possible, since this is always to be calculated projectspecifically on the basis of floor plan geometries, spans and the load-bearing capacity of the building ground.</p>		<p>Due to the high pecigation for sound insulation in the hospital sector, aerated concrete was not taken into account.</p>	<p><b>Weight savings</b></p> <p><b>83%</b></p> <p>32 tons WM111C.2 187 tons Precast concrete parts + ETICS 155 tons Weight savings</p>	<p><b>Weight savings</b></p> <p><b>66%</b></p> <p>32 tons WM111C.2 94 tons Sand lime bricks + ETICS 62 tons Weight savings</p>
<b>Erection time</b>	<p>With a longer production time considerable costs for the personnel employment are connected, additionally a longer building process means a longer supply of building site facilities, whose costs should be minimised. The efficient construction of the Knauf Exterior Wall as well as the shorter drying times and the significantly lower weather dependency compared to massive constructions offer a considerable cost reduction potential and entail much less risk in the planning of the construction process.</p> <p>Additionally, if in masonry constructions, such as aerated concrete or sand-lime brick, the windows are not installed in the insulation layer, the openings must first be measured after erection of the exterior wall. Whereas with the Knauf Exterior Wall, manufacturers can work to precise plans and dimensions and therefore build windows in advance and transport them to the site, ready for immediate installation. A further advantage, which brings considerable time savings.</p>			<p><b>Erection time savings</b></p> <p><b>20%</b></p> <p>36 days WM111C.2 45 days Precast concrete parts + ETICS 9 days Erection time savings</p>	<p><b>Erection time savings</b></p> <p><b>22%<sup>3</sup></b></p> <p>36 days WM111C.2 46 days Sand lime bricks + ETICS 10 days Erection time savings</p>
Revenue-influencing factors <sup>1</sup>		compared to ...	Aerated concrete	Precast concrete parts + ETICS	Sand lime bricks + ETICS
<b>Space</b>	<p>By using the Knauf Exterior Wall more space can be realised inside the building with a comparable thermal insulation value. Consequently, rentable space and resulting rental income are larger. For landlords and investors, the best possible use of the land area plays an important role. By using the Knauf Exterior Wall, this area efficiency and land utilisation are significantly improved.</p>		<p>Due to the high pecigation for sound insulation in the hospital sector, aerated concrete was not taken into account.</p>	<p><b>Space gain when using WM111C.2 compared to precast concrete parts + ETICS</b></p> <p><b>10.24 m<sup>2</sup></b></p>	<p><b>Space gain when using WM111C.2 compared to sand lime bricks + ETICS</b></p> <p><b>6.66 m<sup>2</sup></b></p>
<b>Rental income</b>				<p><b>Additional income through rental (in €/year)<sup>2</sup></b></p> <p><b>€1,228.80</b></p>	<p><b>Additional income through rental (in €/year)<sup>2</sup></b></p> <p><b>€799.20</b></p>

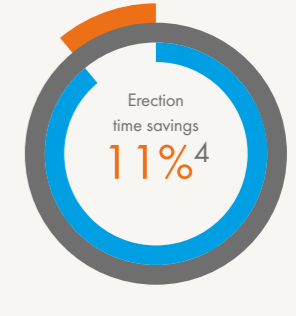
<sup>1</sup>Figures are based on a study by Prof. Dr. Bert Bielefeld of the University of Siegen, Germany. All measurements use comparable U-values.

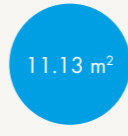
<sup>2</sup>Rental income based (in €/m<sup>2</sup> per month): 10.00€

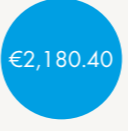
<sup>3</sup>If the windows are not installed in the insulation layer, the erection time savings increase to 52.0 days or 59%.

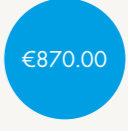
Economic advantages (example: retail shop)		compared with ...	Aerated concrete	Precast concrete parts + ETICS	Sand lime bricks + ETICS
Building perimeter (m): 135 m Floor height: 5.5 m Exterior wall surface per floor: 742.5 m <sup>2</sup> Number of floors: 1 Wall opening share: 50% Opening surface: 371.25 m <sup>2</sup> Net exterior wall surface: 371.25 m <sup>2</sup>					
Cost-influencing factors <sup>1</sup>		compared with ...	Aerated concrete	Precast concrete parts + ETICS	Sand lime bricks + ETICS
<b>Weight</b>	<p>Based on a specific intended use and location of a building, the dead weight is the most important factor of the total loads, which can be influenced by planning. Basically, lower loads enable a leaner structure and thus significant cost savings.</p> <p>The calculation of explicit cost saving amounts for load-bearing walls and ceilings as well as foundations achieved by the weight reduction when using the Knauf Exterior Wall is generically not possible, since this is always to be calculated projectspecifically on the basis of floor plan geometries, spans and the load-bearing capacity of the building ground.</p>		 <p>Weight savings <b>56%</b></p> <p>32 tons WM111C.2 74 tons Aerated concrete 41 tons Weight savings</p>	 <p>Weight savings <b>83%</b></p> <p>32 tons WM111C.2 189 tons Precast concrete parts + ETICS 157 tons Weight savings</p>	 <p>Weight savings <b>66%</b></p> <p>32 tons WM111C.2 95 tons Sand lime bricks + ETICS 63 tons Weight savings</p>
<b>Erection time</b>	<p>With a longer production time considerable costs for the personnel employment are connected, additionally a longer building process means a longer supply of building site facilities, whose costs should be minimised. The efficient construction of the Knauf Exterior Wall as well as the shorter drying times and the significantly lower weather dependency compared to massive constructions offer a considerable cost reduction potential and entail much less risk in the planning of the construction process.</p> <p>Additionally, if in masonry constructions, such as aerated concrete or sand-lime brick, the windows are not installed in the insulation layer, the openings must first be measured after erection of the exterior wall. Whereas with the Knauf Exterior Wall, manufacturers can work to precise plans and dimensions and therefore build windows in advance and transport them to the site, ready for immediate installation. A further advantage, which brings considerable time savings.</p>		 <p>Erection time savings <b>54%<sup>3</sup></b></p> <p>33 days WM111C.2 72 days Aerated concrete 39 days Erection time savings</p>	 <p>Erection time savings <b>8%</b></p> <p>33 days WM111C.2 36 days Precast concrete parts + ETICS 3 days Erection time savings</p>	 <p>Erection time savings <b>11%<sup>4</sup></b></p> <p>33 days WM111C.2 37 days Sand lime bricks + ETICS 4 days Erection time savings</p>
Revenue-influencing factors <sup>1</sup>		compared to ...	Aerated concrete	Precast concrete parts + ETICS	Sand lime bricks + ETICS
<b>Space</b>	<p>By using the Knauf Exterior Wall more space can be realised inside the building with a comparable thermal insulation value. Consequently, rentable space and resulting rental income are larger. For landlords and investors, the best possible use of the land area plays an important role. By using the Knauf Exterior Wall, this area efficiency and land utilisation are significantly improved.</p>		 <p>Space gain when using WM111C.2 compared to aerated concrete <b>18.17 m<sup>2</sup></b></p>	 <p>Space gain when using WM111C.2 compared to precast concrete parts + ETICS <b>11.13 m<sup>2</sup></b></p>	 <p>Space gain when using WM111C.2 compared to sand lime bricks + ETICS <b>7.25 m<sup>2</sup></b></p>
<b>Rental income</b>			 <p>Additional income through rental (in €/year)<sup>2</sup> <b>€2,180.40</b></p>	 <p>Additional income through rental (in €/year)<sup>2</sup> <b>€1,335.60</b></p>	 <p>Additional income through rental (in €/year)<sup>2</sup> <b>€870.00</b></p>

<sup>1</sup>Figures are based on a study by Prof. Dr. Bert Bielefeld of the University of Siegen, Germany. All measurements use comparable U-values.

<sup>2</sup>Rental income based (in €/m<sup>2</sup> per month): 10.00€

<sup>3</sup>The time saved due to immediate window installation is taken into account.

<sup>4</sup>If the windows are not installed in the insulation layer, the erection time savings increase to 45.9 days or 58%.



# CONSTRUCTION DRAWINGS

## Section overview

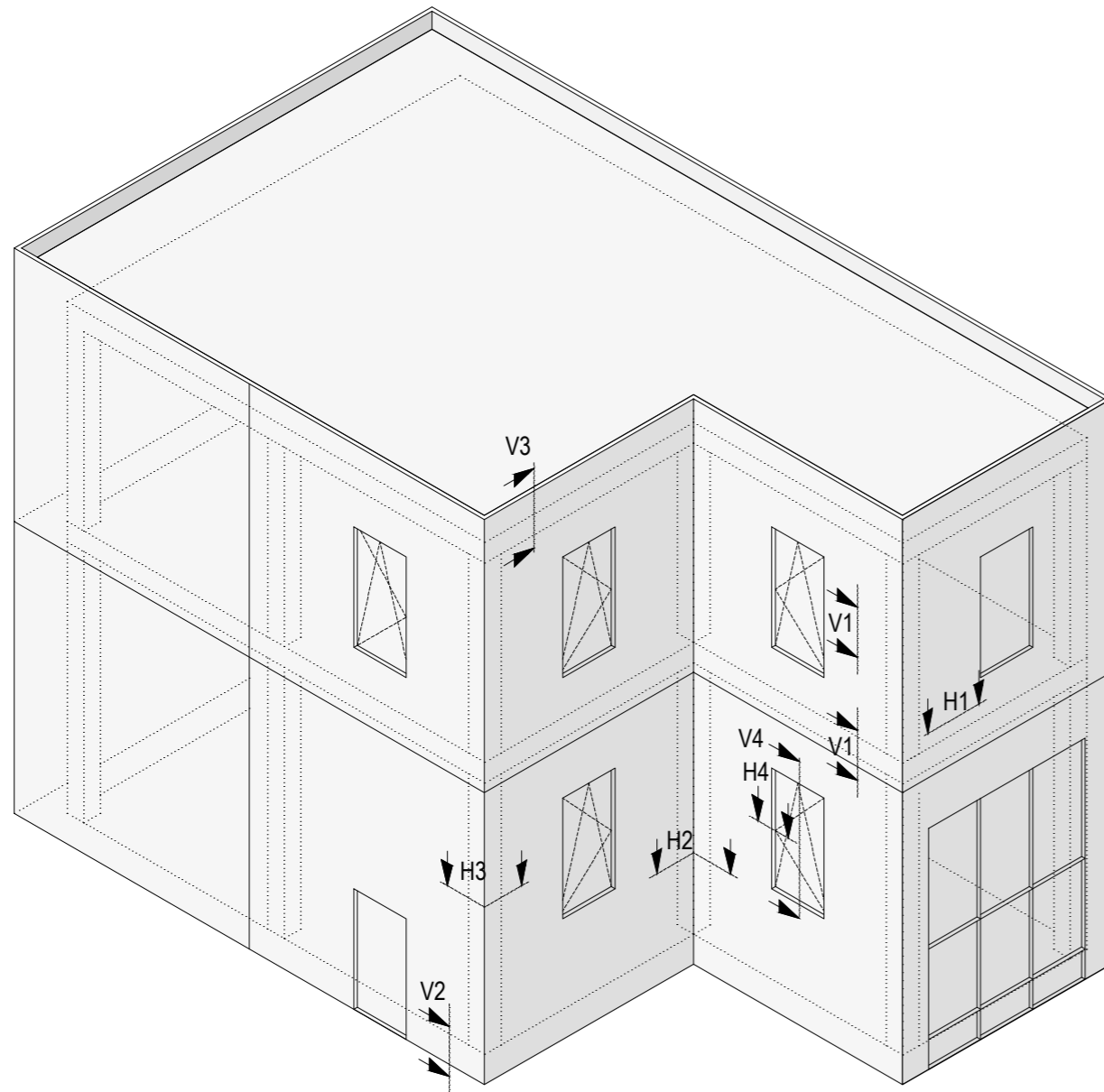

Index	Description
V1	Main section, vertical
V2	Vertical section - connection to base
V3	Vertical section - connection to parapet
V4.1	Vertical section window, lintel
V4.2	Vertical section window, parapet
H1	Main section, horizontal
H2	Horizontal section - interior corner without expansion joint
H3	Horizontal section - exterior corner without column
H4	Horizontal section window

Detail A: Vertical foil lining LDS and connection to floor slab

Details scale 1:2.5

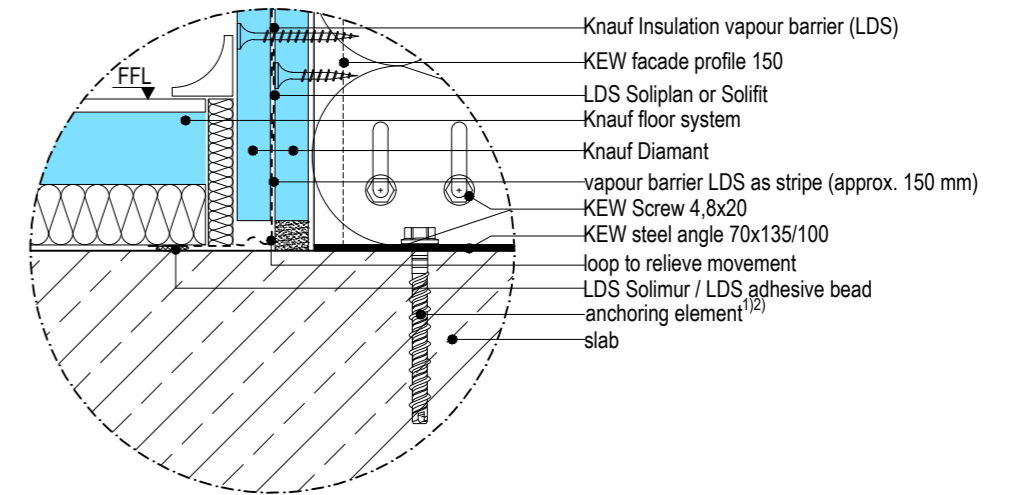

Detail B: Vertical foil lining LDS and connection to ceiling slab

Details scale 1:2.5

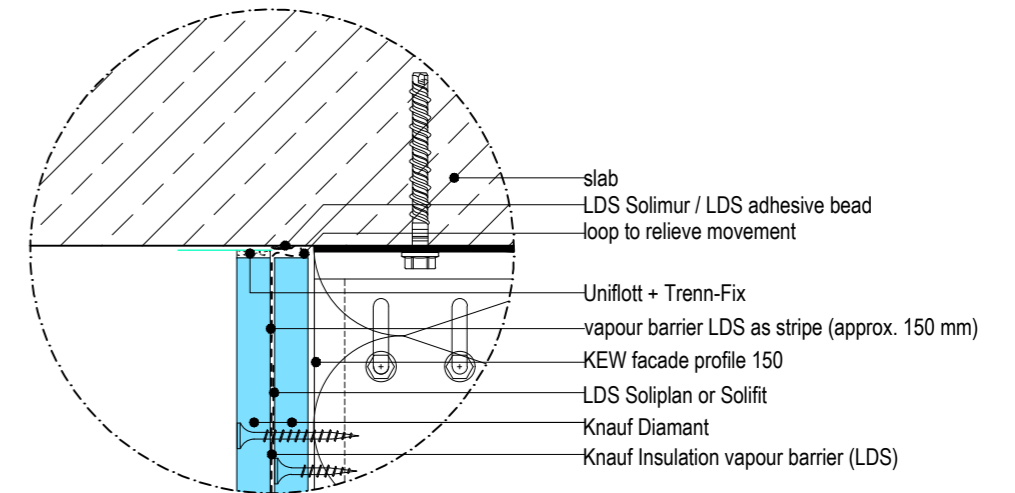

Detail C: Horizontal foil linings and connection to solid wall

Details scale 1:2.5

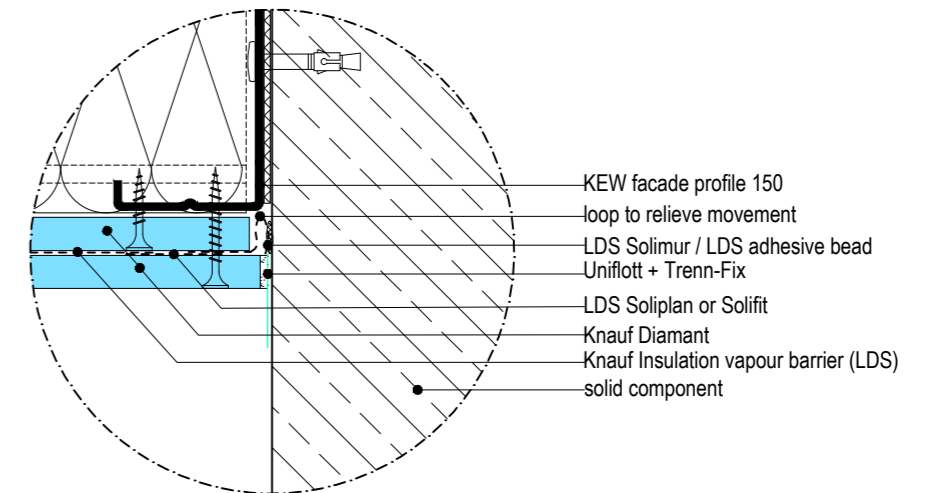

**Notes**

- › The drawings illustrating the general concept of how the system works and interfaces with other construction components.
- › The drawings do not substitute an execution design.
- › Follow the local standards and guidelines for the planning and structural design.
- › The technical specifications and information on the products given in the technical data sheets and system descriptions / approvals must be observed.

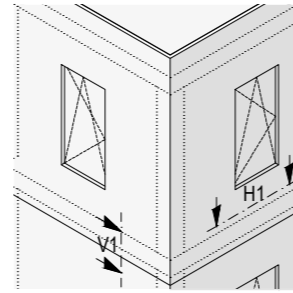

**Notes**

- › The drawings illustrating the general concept of how the system works and interfaces with other construction components.
- › The drawings do not substitute an execution design.
- › Follow the local standards and guidelines for the planning and structural design.
- › The technical specifications and information on the products given in the technical data sheets and system descriptions / approvals must be observed.

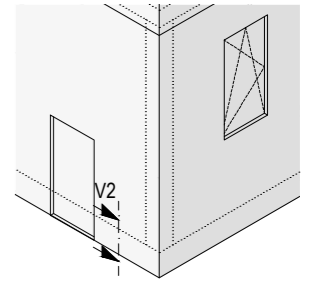

V1 Vertical section - connection to end plate

Details scale 1:5

V2 Vertical section - connection to base

Details scale 1:5

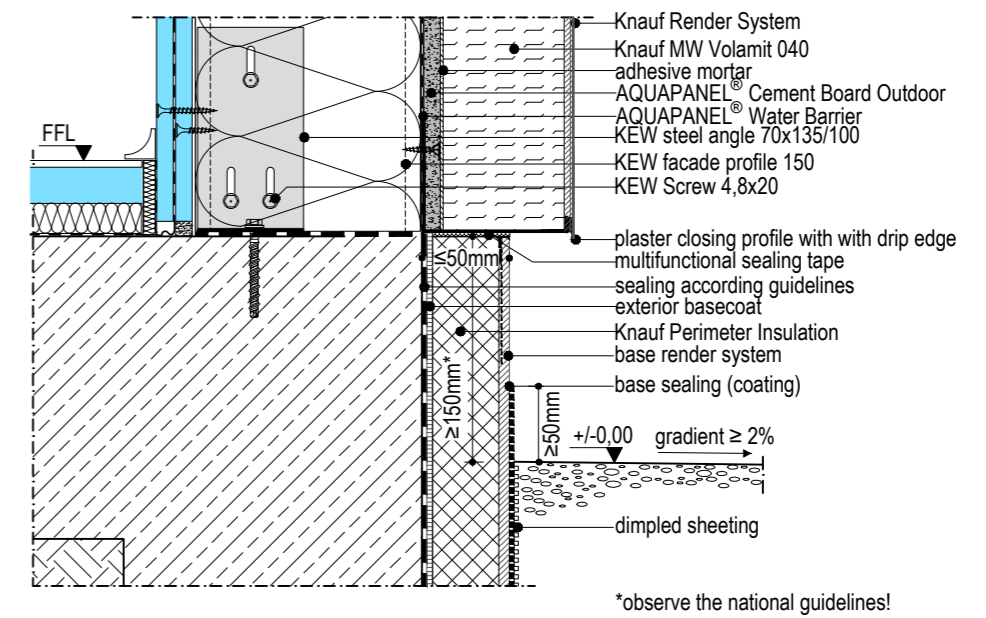
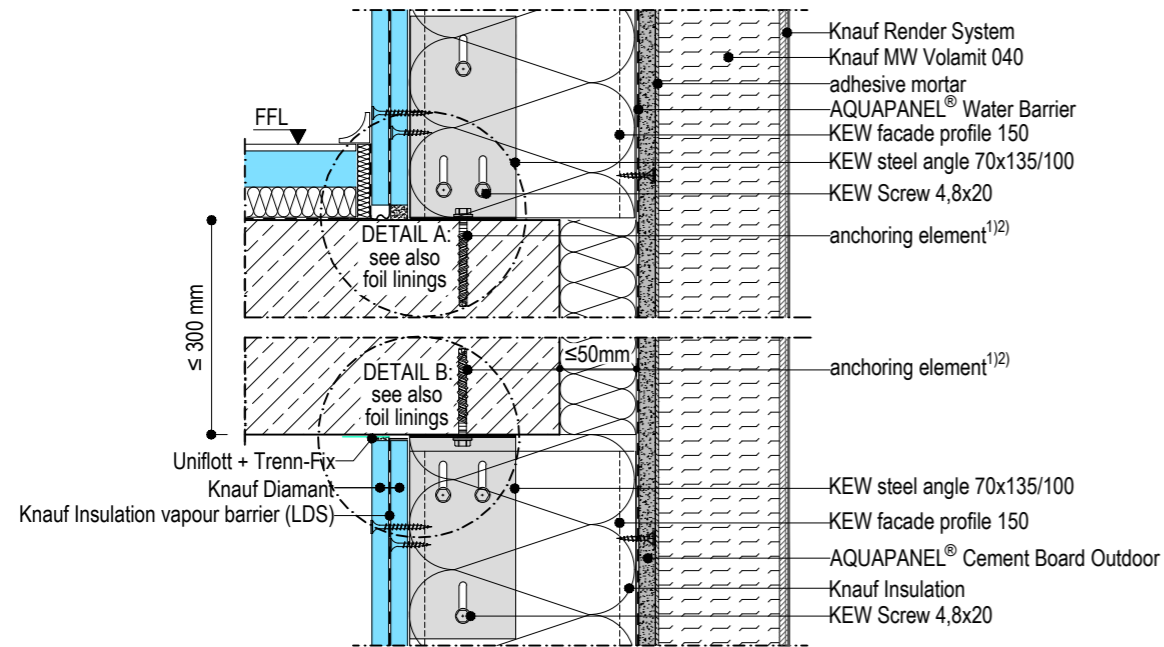

H1 Horizontal section - board joint

Details scale 1:5

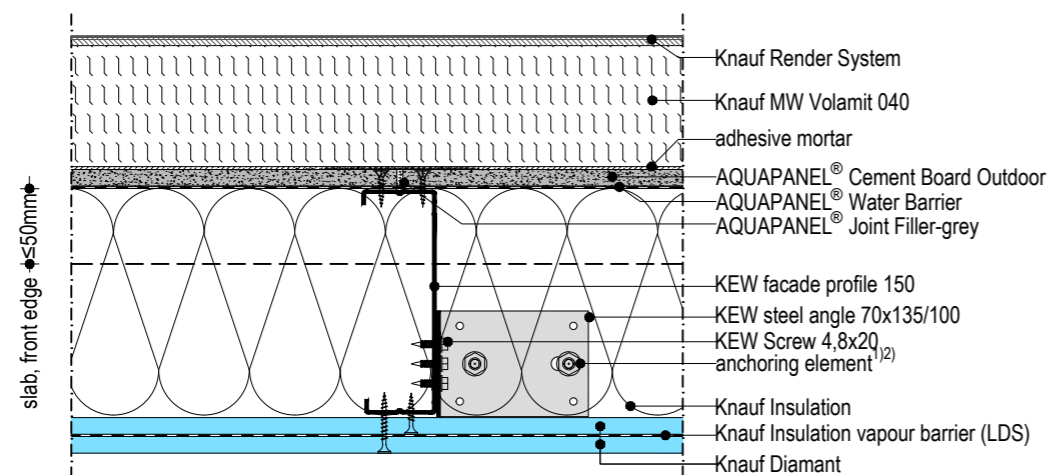

<sup>1</sup>according to static wcalculation    <sup>2</sup>observe edge distance!

<sup>1</sup>according to static calculation    <sup>2</sup>observe edge distance!



**Notes**

- › The drawings illustrating the general concept of how the system works and interfaces with other construction components.
- › The drawings do not substitute an execution design.
- › Follow the local standards and guidelines for the planning and structural design.
- › The technical specifications and information on the products given in the technical data sheets and system descriptions / approvals must be observed.

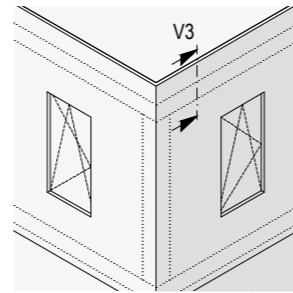

V3 Vertical section - connection to parapet

Details scale 1:5

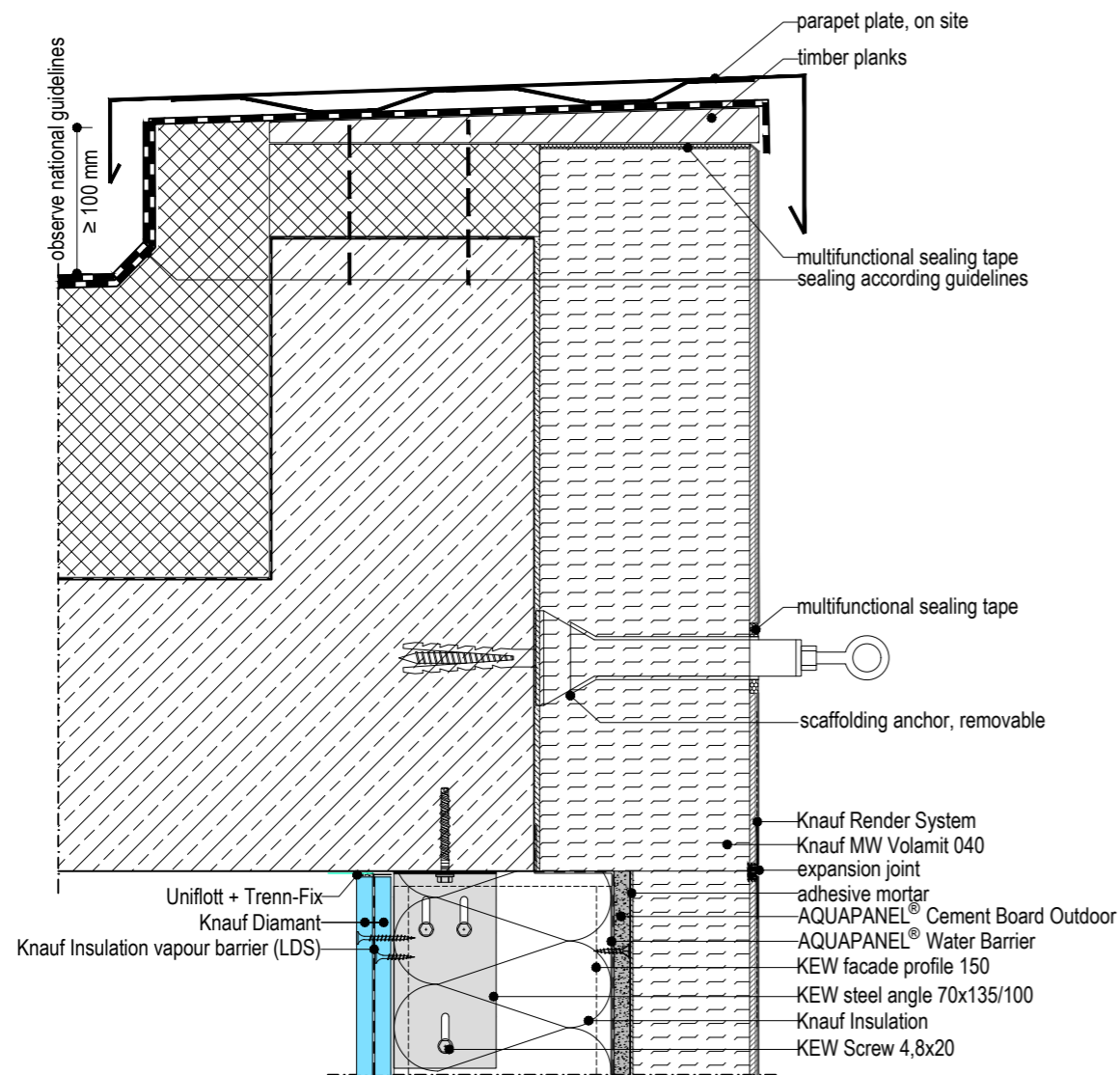

<sup>1</sup>according to static calculation

<sup>2</sup>observe edge distance!

**Notes**

- › The drawings illustrating the general concept of how the system works and interfaces with other construction components.
- › The drawings do not substitute an execution design.
- › Follow the local standards and guidelines for the planning and structural design.
- › The technical specifications and information on the products given in the technical data sheets and system descriptions / approvals must be observed.

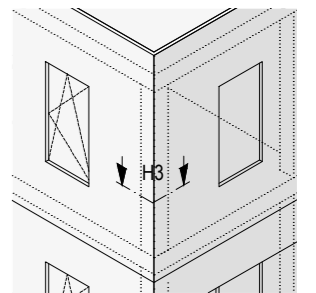

H3 Horizontal section - exterior corner without column

Details scale 1:5

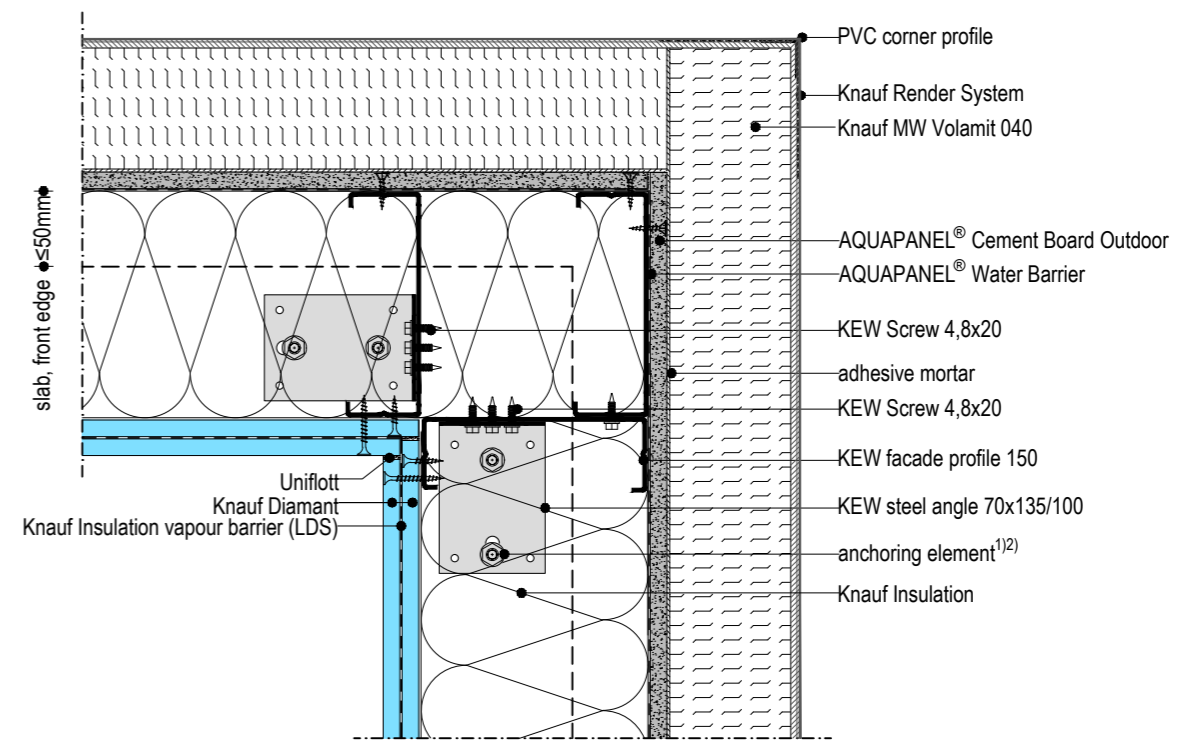

<sup>1</sup>according to static calculation

<sup>2</sup>observe edge distance!

**Notes**

- › The drawings illustrating the general concept of how the system works and interfaces with other construction components.
- › The drawings do not substitute an execution design.
- › Follow the local standards and guidelines for the planning and structural design.
- › The technical specifications and information on the products given in the technical data sheets and system descriptions / approvals must be observed.

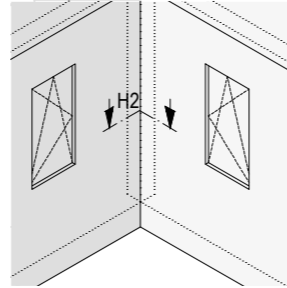

H2 Horizontal section - interior corner without expansion joint

Details scale 1:5

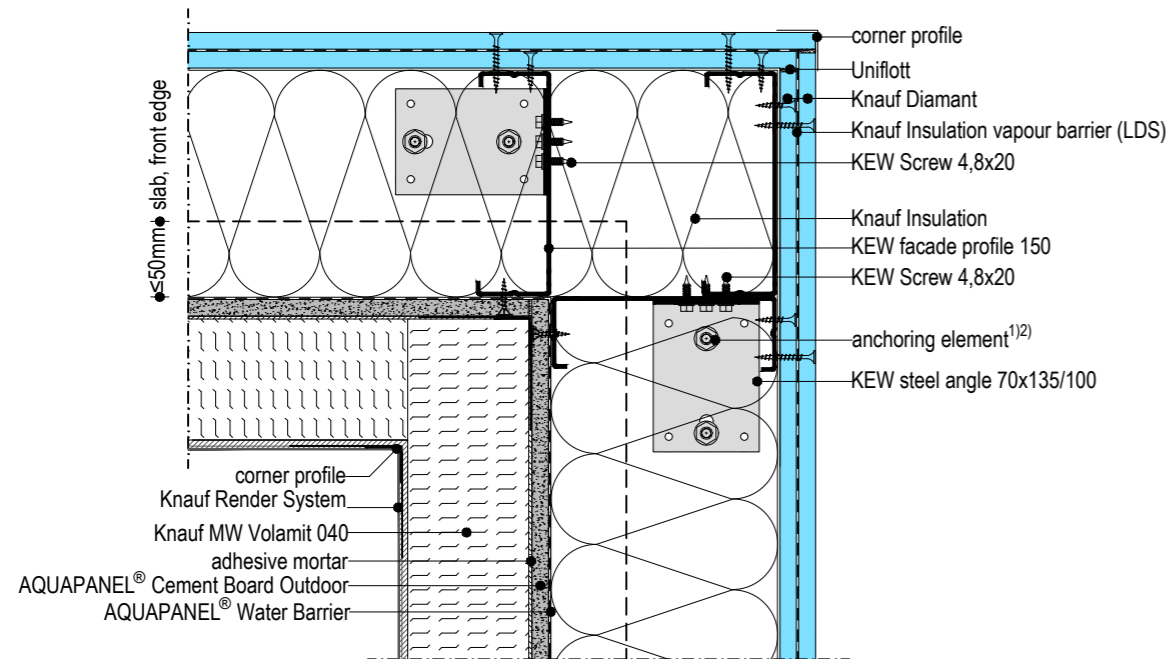

**Notes**

- › The drawings illustrating the general concept of how the system works and interfaces with other construction components.
- › The drawings do not substitute an execution design.
- › Follow the local standards and guidelines for the planning and structural design.
- › The technical specifications and information on the products given in the technical data sheets and system descriptions / approvals must be observed.

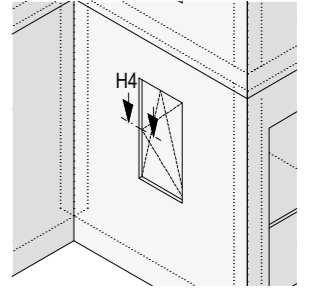
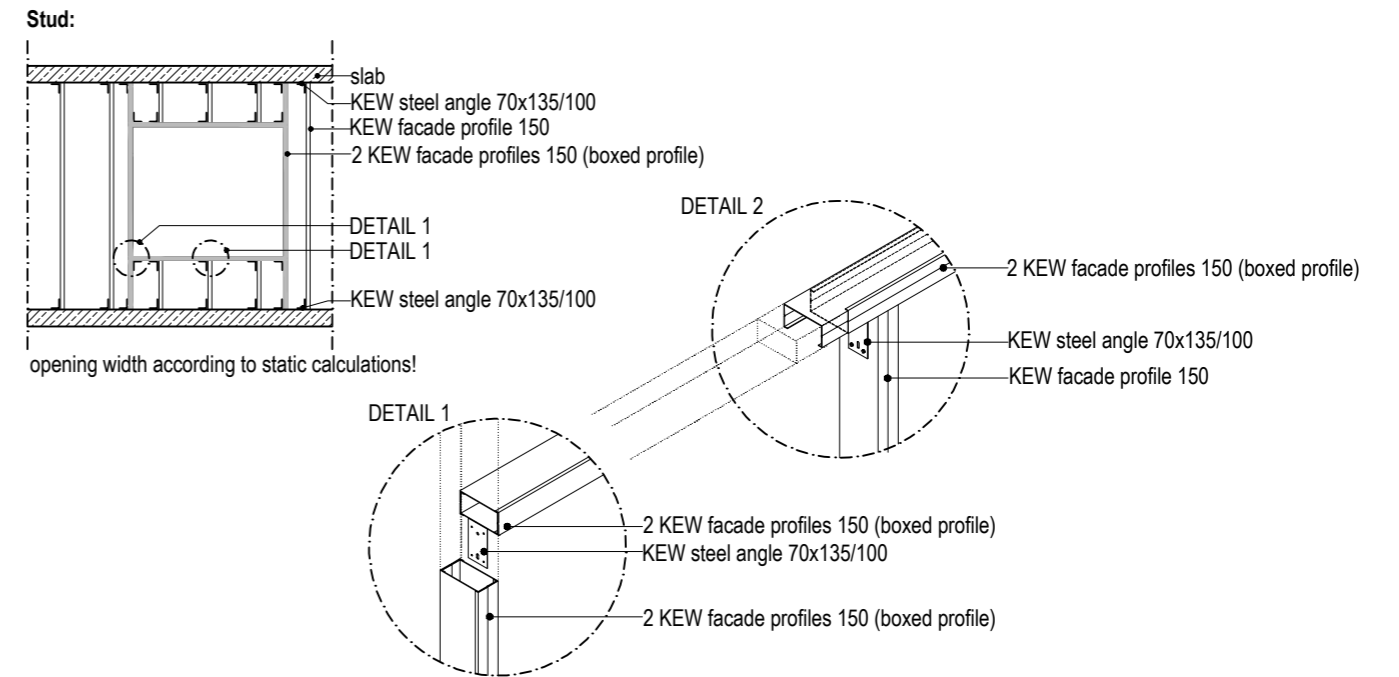
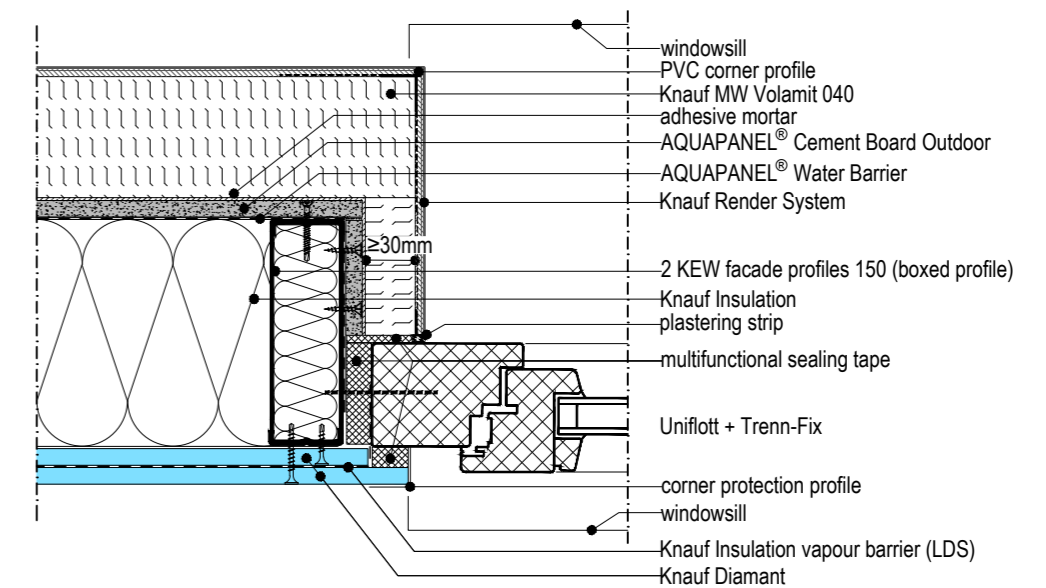

Illustration - Auxiliary structure



H4 Horizontal section - window

Details scale 1:5



<sup>1</sup>according to static calculation

<sup>2</sup>observe edge distance!

<sup>1</sup>according to static calculation

<sup>2</sup>observe edge distance!



**Notes**

- › The drawings illustrating the general concept of how the system works and interfaces with other construction components.
- › The drawings do not substitute an execution design.
- › Follow the local standards and guidelines for the planning and structural design.
- › The technical specifications and information on the products given in the technical data sheets and system descriptions / approvals must be observed.

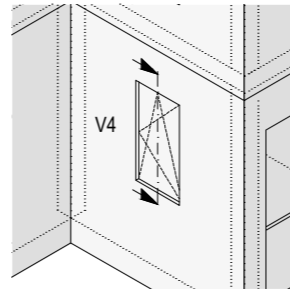

V4.1 Vertical section - lintel

Details scale 1:5

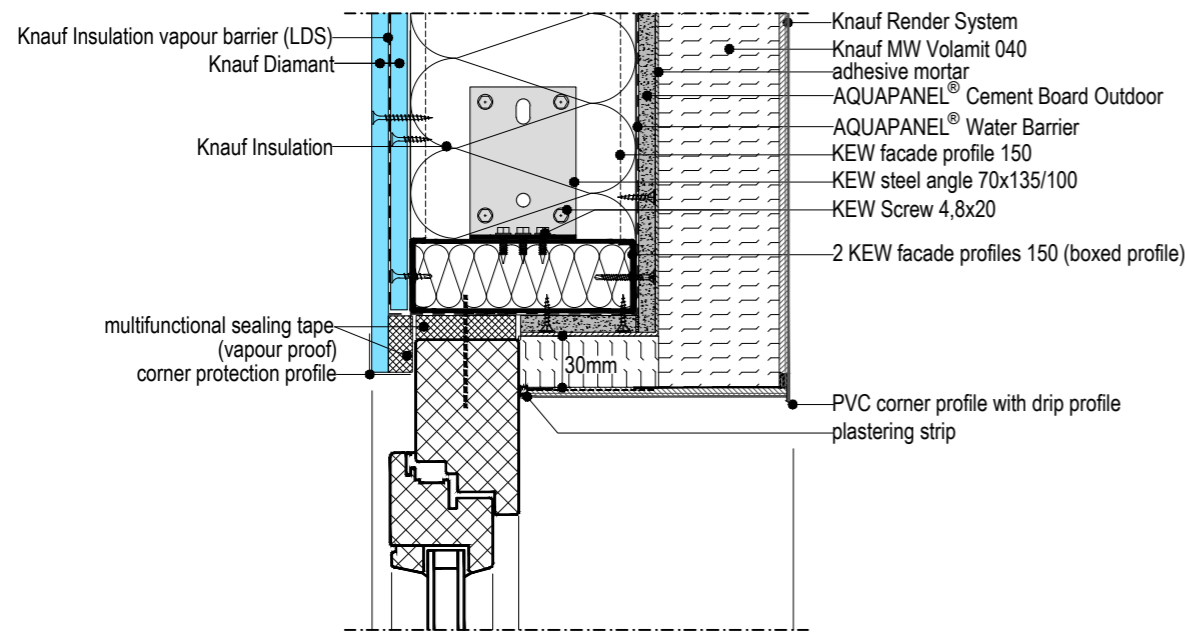

V4.2 Vertical section - parapet

Details scale 1:5

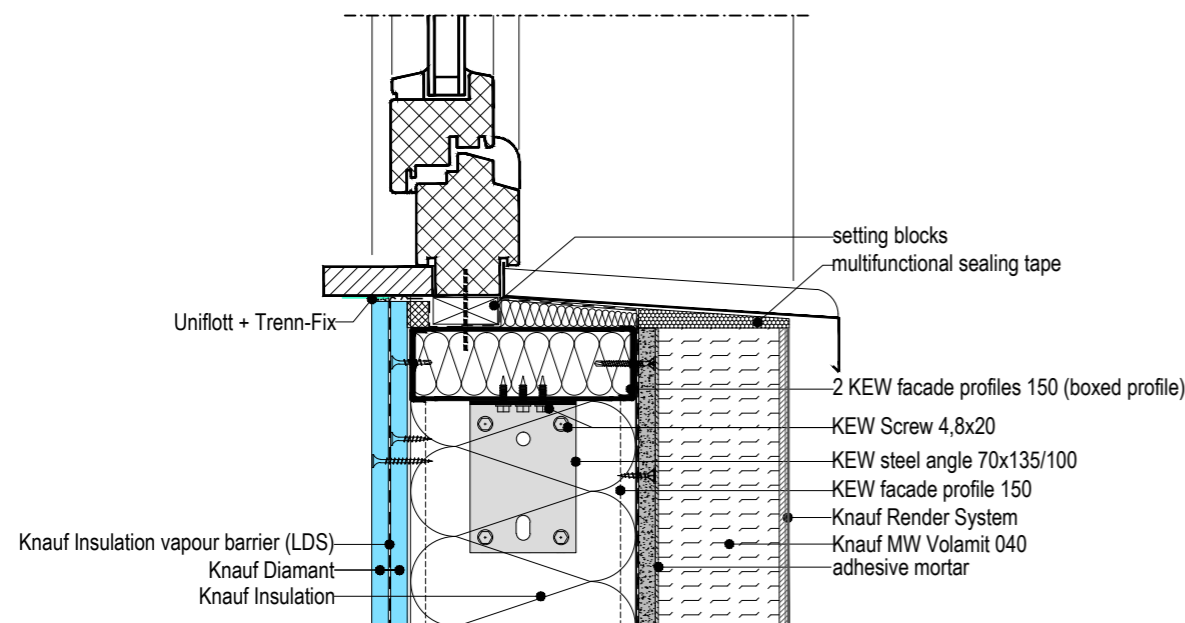

<sup>1</sup>according to static calculation

<sup>2</sup>observe edge distance!

# SPECIFICATIONS

Legend for text selections	
Optional items	Orange
Information to be supplemented by the contracting party	Blue

Item	Quantity	Performance description	Unit price	Total price
1		<p><b>Knauf Exterior Wall as single stud system, installed between floors, type WM111C.2 plus External Thermal Insulation System by customer.</b></p> <p><b>Non load-bearing exterior wall with cement-bonded board as exterior planking; inorganic and approved according to the building regulation, as substrate for different finishing materials and options; application in accordance with the manufacturer's guidelines</b></p> <p><b>One shell consisting of metal studs to include thermal insulation, described in details below; friction-locked and tension-free fixed to the floor slabs, and if necessary to columns and walls.</b></p> <p><b>The stud frame is consisting of KEW Profiles 150. Friction-locked and tension-free connection to the floor slabs with KEW Steel Angle 70x135/100 fixed to the profile with KEW Screw; type, dimension and quantity of the fasteners and fixing elements depending on structural requirements and to be approved according to the building regulations.</b></p> <p>The stud frame is to be aligned accurately and delivered as well as installed according to the following specification. Corrosion protection according to EN ISO 12944-2, but minimum Category C3.</p> <p>The following formal dimensions and cross-sections are minimum requirements. The application has to be carried out according to a verifiable structural analysis.</p> <p>Thermal insulation of the façade construction, consisting of: mineral insulation board according to EN 13162, non-combustible A1 according to EN 13501-1. Thermal conductivity <math>\lambda = 0.035 \text{ W/m}^2\text{K}</math>, water repellent.</p> <p>Constructional specifications:</p> <p>Thermal insulation: _____ <math>\text{W/m}^2\text{K}</math></p> <p>Sound insulation: _____ <math>\text{dB}</math> (rated soundproofing)</p> <p>Fire protection: _____</p>		

Delete as applicable

Legend for text selections	
Optional items	Orange
Information to be supplemented by the contracting party	Blue

Item	Quantity	Performance description	Unit price	Total price
1.10		<p><b>Façade constructions and insulating materials</b></p> <p><b>Knauf Aquapanel single stud. between floors, type WM111C.2</b></p> <p><b>Standard build-up – inside to outside (without fire protection requirement).</b></p> <p><b><u>The dimensions can vary according to static or constructive requirements:</u></b></p> <ul style="list-style-type: none"> <li>› 12.5 mm gypsum board, Knauf wall board impregnated (GKBI/H2)</li> <li>› Knauf Insulation vapour barrier layer LDS 10 Silk</li> <li>› 12.5 mm gypsum board, Knauf wall board impregnated (GKBI/H2)</li> <li>› Knauf KEW Profile 150 with thermal insulation board acc. to local requirements; stud distance: <b>600 or 400</b> mm incl. the fixation at top and bottom slab with KEW Steel Angle 70x135/100; incl. anchoring according to the static calculation</li> <li>› Aquapanel Water Barrier</li> <li>› Aquapanel Cement Board Outdoor with Aquapanel joint tape 10 cm and joint filler grey</li> </ul> <p><b>The ETIC System, Knauf Warm-Wand System is specified separately.</b></p> <p>Deliver construct and assemble according to the enclosed planning and documentation in accordance with the manufacturer’s instructions, complete and ready-made.</p> <p>000,000 m<sup>2</sup> .....</p>		

Delete as applicable

Legend for text selections	
Optional items	Orange
Information to be supplemented by the contracting party	Blue

Item	Quantity	Performance description	Unit price	Total price
1.20		<p><b>In addition – window opening</b></p> <p>The construction of a window opening, in addition to item 1.10, incl. connection work to the windows and window sills, interior and exterior.</p> <p>Opening size: <b>L X W</b>                      Other: Incl. all render profiles, sealing tapes, corner protection profiles, diagonal render reinforcements, etc.</p> <p>Deliver, construct and assemble according to the enclosed planning and documentation in accordance with the manufacturer’s instructions, complete and ready-made.</p> <p>000,000 Unit .....</p>		
1.30		<p><b>In addition – door/gate opening</b></p> <p>The construction of a door/gate opening, in addition to item 1.10, incl. connection work to the door/gate, interior and exterior</p> <p>Opening size: <b>L X W</b>                      Other: Incl. all render profiles, sealing tapes, corner protection profiles, diagonal render reinforcements, etc.</p> <p>Deliver, construct and assemble according to the enclosed planning and documentation in accordance with the manufacturer’s instructions, complete and ready-made.</p> <p>000,000 Unit .....</p>		
1.40		<p><b>In addition – metal-glass façade (Column and beam construction)</b></p> <p>The construction of an opening for a metal-glass façade, in addition to item 1.10 incl. connection work to the metal-glass façade, interiors and exteriors</p> <p>Opening size: <b>L X W</b>                      Other: Incl. all render profiles, sealing tapes, corner protection profiles, diagonal render reinforcements, etc.</p> <p>Deliver, construct and assemble according to the enclosed planning and documentation in accordance with the manufacturer’s instructions, complete and ready-made.</p> <p>000,000 Unit .....</p>		

Delete as applicable



Legend for text selections	
Optional items	Orange
Information to be supplemented by the contracting party	Blue

Item	Quantity	Performance description	Unit price	Total price
1.50		<p><b>In addition – on-site penetration</b></p> <p>Construction of a penetration in addition to item 1.10 (e.g. pipes, emergency spillways, etc.); incl. connection work; use suitable sealing material, e. g. Compriband or similar, exteriors</p> <p>Opening size: <b>L X W</b>                      Other: Incl. all plaster strips, sealing tapes, corner protection rails, diagonal reinforcements, etc.</p> <p>Deliver, construct and assemble according to the enclosed planning and documentation in accordance with the manufacturer’s instructions, complete and ready-made.</p> <p>000,000 Unit .....</p>		
1.60		<p><b>In addition – outside corner of façade</b></p> <p>Construction of an external corner of a façade in addition to item 1.10, incl. all corner profiles, etc.</p> <p>Deliver, construct and assemble according to the enclosed planning and documentation in accordance with the manufacturer’s instructions, complete and ready-made.</p> <p>000,000 m .....</p>		
1.70		<p><b>In addition – inside corner of façade</b></p> <p>Construction of an internal corner of a façade in addition to item 1.10, incl. corner reinforcement, etc.</p> <p>Deliver, construct and assemble according to the enclosed planning and documentation in accordance with the manufacturer’s instructions, complete and ready-made.</p> <p>000,000 m .....</p>		

Delete as applicable

Legend for text selections	
Optional items	Orange
Information to be supplemented by the contracting party	Blue

Item	Quantity	Performance description	Unit price	Total price
1.80		<p><b>In addition – expansion joint (horizontal/vertical)</b></p> <p>Construction of system-related expansion joints in addition to item 1.10, incl. all expansion joint profiles</p> <p>Deliver, construct and assemble according to the enclosed planning and documentation in accordance with the manufacturer’s instructions, complete and ready-made.</p> <p>000,000 m .....</p>		
1.90		<p><b>In addition – structural joint</b></p> <p>Construction of a structural joint in addition to item 1.10, incl. all expansion joint profiles.</p> <p>Deliver, construct and assemble according to the enclosed planning and documentation in accordance with the manufacturer’s instructions, complete and ready-made.</p> <p>000,000 m .....</p>		

Delete as applicable

Legend for text selections	
Optional items	Orange
Information to be supplemented by the contracting party	Blue

Item	Quantity	Performance description	Unit price	Total price
<b>1.1</b>		<b>Surface treatment interiors</b>		
<b>1.1.10</b>		<p><b>Interior finish – gypsum board</b></p> <p>Filling the joints of gypsum boards with Knauf Uniflott and cover the screw heads, quality level Q2</p> <p>Location: elevation no. : _____ axis no. : _____</p> <p>Miscellaneous: Incl. reveals and lintels</p> <p>Deliver, construct and assemble according to the enclosed planning and documentation in accordance with the manufacturer’s instructions, complete and ready-made.</p> <p>000,000 m² .....</p>		

Delete as applicable

Legend for text selections	
Optional items	Orange
Information to be supplemented by the contracting party	Blue

Item	Quantity	Performance description	Unit price	Total price
<b>1.2</b>		<b>Further services</b>		
<b>1.2.10</b>		<p><b>*** Optional item: Scaffolding brackets</b></p> <p>GELOG scaffolding brackets for the described wall structure, dimensioning according to statics. Deliver, construct and assemble according to the enclosed planning and documentation in accordance with the manufacturer’s instructions, complete and ready-made.</p> <p>000,000 Unit .....</p>		
<b>1.2.20</b>		<p><b>Detail and implementation planning</b></p> <p>Preparation of the detail and implementation planning, incl. the details and installation plans for the steel substructure and the AQUAPANEL® Cement Board Outdoor as well as the anchoring system.</p> <p>Before execution, all planning and construction results have to be signed off by the contractor and the structural engineer.</p> <p>1 lump sum .....</p>		
<b>1.2.30</b>		<p><b>Proof of stability</b></p> <p>Preparation of verifiable static calculation of the substructure, incl. screw connections, dowels, anchors, etc. This must be submitted by the contractor before start of execution and signed off by the responsible inspecting structural engineer.</p> <p>1 lump sum .....</p>		
<b>1.2.40</b>		<p><b>*** Optional item: Mock-up</b></p> <p>Creation of a complete mock-up, Size: approx. a x b m Location: elevation no. : _____ axis no. : _____</p> <p>Mock-up for subsequent incorporation into the façade / Mock-up has to be removed afterwards / Mock-up will be erected separately from site (location to be defined)</p> <p>If necessary in coordination with other disciplines as specified by the architect.</p> <p>Deliver, construct and assemble according to the enclosed planning and documentation in accordance with the manufacturer’s instructions, complete and ready-made.</p> <p>1 lump sum .....</p>		



Delete as applicable



# PRODUCT RANGE

## Stud framework



Easy to work with and install, the components used to create our stud frames include profiles, angles, screws and sealing strips, all available in a wide range of specifications and geometries to meet any design requirement. All profiles have organic coating and galvanizing (minimum corrosion category C3 according to EN ISO 12944) to ensure long-term protection.

Profiles		Web height (mm)	Flange width (mm)	Nominal thickness (mm)	Weight (approx kg/m)
<b>Knauf Exterior Wall Profile 150</b>		150	50	1.0	2.0
<ul style="list-style-type: none"> <li>Point of use: exterior stud frame</li> <li>Designed to absorb and transmit wind and dead loads</li> <li>Interlaceable</li> <li>Enables a preliminary static design according to EUROCODE 3 (in combination with Knauf Exterior Wall Steel Angle and Knauf Exterior Wall Screw)</li> <li>Black coated</li> <li>Minimum corrosion protection C3</li> </ul>					
Connecting angles			Width (mm)	Length (mm)	Nominal thickness (mm)
<b>Knauf Exterior Wall Steel Angle 70x135/100</b>			70	135/100	1.5
<ul style="list-style-type: none"> <li>Black coated</li> <li>Enables a preliminary static design according to EUROCODE 3 (in combination with Knauf Exterior Wall Profile and Knauf Exterior Wall Screw)</li> <li>Minimum corrosion protection C3</li> </ul>					
Screws and anchors				Width (mm)	Length (mm)
<b>Knauf Exterior Wall Screw</b>				4.8	20
<ul style="list-style-type: none"> <li>Rustproofed screw</li> <li>Hardened nail tip</li> <li>Suitable for metal thickness up to 1.2mm</li> <li>Enables a preliminary static design according to EUROCODE 3 (in combination with Knauf Exterior Wall Profile and Knauf Exterior Wall Steel Angle)</li> </ul>					

## Insulation

Available in panels and rolls for easy installation, mineral wool from Knauf Insulation is suitable for a wide range of applications, including inside stud frames, as well as in front of floors to reduce thermal bridges between the Knauf Exterior Wall with AQUAPANEL® Technology and concrete slabs.

In addition, Knauf's MW Volamit 040 is widely used for ETICS applications and is available in easy to handle lamella formats and does not require the use of dowelling.

Insulation for metal constructions			Width (mm)	Length (mm)	Thickness (mm)	m <sup>2</sup> / Package
<b>Knauf Insulation Metallbau-Dämmplatte FCB 035</b>		<ul style="list-style-type: none"> <li>Insulation board</li> <li>Thermal conductivity rating: 035</li> <li>Glass mineral wool</li> <li>ECOSE® Technology</li> <li>Non-combustible</li> </ul>	625	1,250	50	9.38
					75	6.25
					150	3.13
<b>Knauf Insulation Universalrolle classic 035</b>		<ul style="list-style-type: none"> <li>Insulation roll</li> <li>Thermal conductivity rating: 035</li> <li>Glass mineral wool</li> <li>ECOSE® Technology</li> <li>Non-combustible</li> </ul>	1,200	13,000	40	15.60
				10,500	50	12.60
				8,700	60	10.44
				6,300	80	7.56
				5,200	100	6.24
				4,400	120	5.28
				3,700	140	4.44
				3,300	160	3.96
				2,900	180	3.48
				2,600	200	3.12
				2,900	220	3.48
				2,700	240	3.24
Mineral wool lamella for External Thermal Insulation Composite Systems (ETICS)			Width (mm)	Length (mm)	Thickness (mm)	m <sup>2</sup> /pcs
<b>MW Volamit 040</b>		<ul style="list-style-type: none"> <li>Stone mineral wool lamella</li> <li>Non-combustible</li> <li>Double-sided adhesive coating (only for thicknesses 60mm-220mm)</li> <li>Thermal conductivity rating: 040</li> <li>Pressure-resistant</li> </ul>	200	1,200	60	0.24
					80	
					100	
					120	
					140	
					160	
					180	
					200	
					220	
					240	
					260	
					280	
					300	
Special thicknesses <300						

Adhesive mortar for mineral wool insulation (ETICS)		Coverage (approx kg/m <sup>2</sup> )	Storage life (approx month)	Weight (kg/bag)
<b>Pastol Dry</b>	 <ul style="list-style-type: none"> <li>Organic powder-based adhesive mortar in External Thermal Insulation Composite Systems (ETICS)</li> <li>For bonding mineral wool to board materials</li> <li>Fibre-reinforced</li> <li>Water-repellent</li> <li>Colour: natural white</li> </ul>	2.4 (2mm layer thickness)	12	20



**Exterior lining**

To ensure that the Knauf Exterior Wall acquires its water resistant properties, AQUAPANEL® Cement Board Outdoor is fitted on top of AQUAPANEL® Water Barrier, a highly windproof, rainproof and permeable layer which can be easily fixed on exterior studs by using adhesive tape. Complemented with specially developed system accessories including AQUAPANEL® Joint Filler, AQUAPANEL® Tape as well as AQUAPANEL® Maxi Screws with special coatings for added corrosion protection, the result is a complete – and completely reliable – lining system of AQUAPANEL® products.

Water barrier		Width (mm)	Roll Length (mm)
<b>AQUAPANEL® Water Barrier</b>	 <ul style="list-style-type: none"> <li>Water resistant and wind tight membrane</li> <li>Used as a water conducting layer directly behind AQUAPANEL® Cement Board Outdoor</li> <li>Diffusion equivalent air layer thickness (sd): 0.025m</li> </ul>	1,500	50,000



Adhesive tapes		Width (mm)	Roll Length (mm)
<b>Knauf Insulation LDS Solitop</b>	 <ul style="list-style-type: none"> <li>One-sided reinforced adhesive tape made of polyethylene</li> <li>Specially developed for outdoor use</li> <li>Used for bonding overlaps and penetrations of the AQUAPANEL® Water Barrier</li> </ul>	60 150	40,000 25,000

Cement boards		Width (mm)	Length (mm)	Thickness (mm)	Weight (approx kg/m <sup>2</sup> )
<b>AQUAPANEL® Cement Board Outdoor</b>	 <ul style="list-style-type: none"> <li>Cement board</li> <li>Easy Edge™</li> <li>Building material class: A1, non-combustible</li> <li>100% water resistant</li> <li>Bending radius 1-3m (in dry state)</li> </ul>	900	1,200	12.5	16
		900	1,250		
		900	2,400		
		900	2,500		
		1,200	900		
		1,200	2,000		
		1,200	2,400		
		1,200	2,500		
		1,200	2,800		
		1,200	3,000		
		1,250	900		
		1,250	2,000		
		1,250	2,500		

Screws		Length (mm)
<b>AQUAPANEL® Maxi Screw SN25</b>	 <ul style="list-style-type: none"> <li>With countersunk head and nail tip</li> </ul>	25
<b>AQUAPANEL® Maxi Screw SN39</b>		29
<b>AQUAPANEL® Maxi Screw SN55</b>		55
<b>AQUAPANEL® Maxi Screw SB25</b>	 <ul style="list-style-type: none"> <li>With countersunk head and drill tip</li> </ul>	25
<b>AQUAPANEL® Maxi Screw SB39</b>		39



Material of substructure	Steel framework				
Metal thickness	0.6mm ≤ x ≤ 1.0mm			1.0mm < x ≤ 2.0mm	
Amount of board layers	Single layer	Double layer	Triple layer	Single layer	Double layer
<b>AQUAPANEL® Maxi Screw SN25</b>	x				
<b>AQUAPANEL® Maxi Screw SN39</b>	x	x			
<b>AQUAPANEL® Maxi Screw SN55</b>			x		
<b>AQUAPANEL® Maxi Screw SB25</b>				x	
<b>AQUAPANEL® Maxi Screw SB39</b>				x	x

Joint filler		Coverage (ca kg/m <sup>2</sup> )	Storage life (approx month)	Weight (kg/bag)
<b>AQUAPANEL® Joint Filler – grey</b>	 <ul style="list-style-type: none"> <li>Cement-bound joint filling material</li> <li>Full-surface skimcoating of joints</li> <li>Reinforced with AQUAPANEL® Tape 10cm</li> </ul>	0.7	12	20

Joint tapes		Width (mm)	Roll length (mm)
<b>AQUAPANEL® Tape 10cm</b>	 <ul style="list-style-type: none"> <li>Glass fabric joint tape</li> <li>Alkali-resistant coating</li> <li>Colour: blue</li> <li>Mesh size: 4x4mm</li> </ul>	100	50,000
			20,000
<b>AQUAPANEL® Exterior Reinforcing Tape</b>	 <ul style="list-style-type: none"> <li>Glass fabric joint tape</li> <li>Alkali-resistant coating</li> <li>Colour: blue</li> <li>Mesh size: 4x4mm</li> </ul>	200	50,000

## Exterior finishing

Knauf Exterior Wall is able to accommodate a wide range of finishes, so whatever you want to achieve, it's achievable. In terms of external thermal insulation composite systems (ETICS), Knauf offers a selection of renders to increase choice and design possibilities.







Basecoats		Coverage (ca kg/m <sup>2</sup> )	Storage life (approx month)	Weight (kg/bag)	
<b>SM700 Pro</b>		<ul style="list-style-type: none"> <li>Mineral basecoat</li> <li>Fibre-reinforced</li> <li>Used as a basecoat in External Thermal Insulation Composite Systems (ETICS) – e.g. Knauf WARM WALL Plus</li> <li>Colour: white (special colours available on request)</li> </ul>	7.0-13.0 (5mm - 10mm layer thickness)	12	25
Reinforcing mesh			Width (mm)	Roll length (mm)	
<b>Armiergewebe 4x4mm</b>		<ul style="list-style-type: none"> <li>Alkali-resistant coating</li> <li>Colour: white with blue markings</li> <li>Used as a reinforcing mesh in External Thermal Insulation Composite Systems (ETICS) – e.g. Knauf WARM WALL Plus</li> <li>Mesh size: 4x4mm</li> <li>Initial tear strength: approx. 2000N/5cm</li> <li>Approx. 165g/m<sup>2</sup></li> </ul>	1,000	50,000	



## Interior lining

Knauf Exterior Wall systems include an unrivalled choice of fully compatible lining boards to meet any specification need, including moisture rating, impact resistance, fire rating and sound reduction. For specialist applications in wet and humid areas, AQUAPANEL® Cement Board Indoor has been specifically developed to provide a robust and reliable solution, including in swimming pools and steam saunas. All boards come with comprehensive accessories including vapour control layers, sealant tapes, joint fillers, adhesives and screws.

Vapour barriers		Width (mm)	Roll length (mm)	
<b>Knauf Insulation LDS 10 Silk</b>		<ul style="list-style-type: none"> <li>Vapour control membrane made of high strength polypropylene spun-bonded fabric</li> <li>Diffusion equivalent air layer thickness (sd): 10m</li> <li>Approx 140g/m<sup>2</sup></li> </ul>	3,000	50,000
Adhesive tapes		Width (mm)	Roll length (mm)	
<b>Trenn-Fix</b>		<ul style="list-style-type: none"> <li>Special coated paper strip</li> <li>Adhesive along one edge</li> <li>Used as separation strip between dry-built surfaces and other constructional elements</li> <li>Used between dry-built surfaces to generate a sliding separation</li> </ul>	65	50,000
<b>Knauf Insulation LDS Soliplan</b>		<ul style="list-style-type: none"> <li>One-sided adhesive tape made of kraft paper</li> <li>Used for durable air-tight bonding of vapour barrier overlaps and fitting edges</li> </ul>	60	40,000
<b>Knauf Insulation LDS Solitwin</b>		<ul style="list-style-type: none"> <li>One-sided reinforced adhesive tape made of low-density polyethylene (LDPE)</li> <li>With centre-slit backing paper</li> <li>Used for durable and elastic air-tight bonding of the vapour barrier in corner areas and window connections</li> </ul>	60	25,000
<b>Knauf Insulation LDS Solifit</b>		<ul style="list-style-type: none"> <li>One-sided reinforced adhesive tape made of low-density polyethylene (LDPE)</li> <li>Used for durable and elastic air-tight bonding of vapour barrier overlaps and penetrations, when flexible connections are necessary (e.g. pipes, beams, etc.)</li> </ul>	60	25,000
<b>Knauf Insulation LDS Solifit S</b>		<ul style="list-style-type: none"> <li>One-sided reinforced adhesive tape made of low-density polyethylene (LDPE)</li> <li>Used for durable and elastic air-tight bonding of vapour barrier overlaps and penetrations, when flexible connections are necessary (e.g. pipes, beams, etc.)</li> <li>No peeling, collection and disposal of the release paper required</li> <li>Easy handling by finger lift</li> <li>Tape tears by hand</li> </ul>	60	25,000
<b>Knauf Insulation LDS Kleberaube</b>		<ul style="list-style-type: none"> <li>Elastic, double-sided adhesive tape</li> <li>Used for safe, durable and elastic bonding of the vapour barrier to flanking building parts</li> </ul>	25	8,000



Liquid adhesive		Capacity (ml)	Storage life (approx month)		
<b>Knauf Insulation LDS Solimur</b> 	<ul style="list-style-type: none"> <li>Elastic, durably strong special adhesive</li> <li>Used for safe, durable and elastic bonding of the vapour barrier to flanking building parts</li> </ul>	600	24		
		310	24		
Adhesive primer		Coverage (approx m)	Storage life (approx month)		
<b>Knauf Insulation LDS Primer</b> 	<ul style="list-style-type: none"> <li>Dispersion-based adhesive primer</li> <li>To enhance adhesion of LDS adhesive tapes and LDS Solimur to porous substrates to guarantee a durable adhesive bond</li> </ul>	25-30 (100mm application width)	18		
Air-tight sleeves		Diameter (mm)	Width (mm)	Length (mm)	
<b>Knauf Insulation LDS Universalmanschette</b> 	<ul style="list-style-type: none"> <li>Multi-purpose sleeve</li> <li>Two-layer polypropylene spun-bonded fabric</li> <li>For fast and professional, in particular retrospective sealing of pipe openings in the vapour barrier</li> </ul>	75-125	400	400	
<b>Knauf Insulation LDS Leitungsmanschette</b> 	<ul style="list-style-type: none"> <li>Cable sleeve</li> <li>Self-adhesive kraft paper</li> <li>For professional sealing of cable feed-throughs</li> </ul>	8-12	150	150	
<b>Knauf Insulation LDS Leitungsmanschette 6-fach</b> 	<ul style="list-style-type: none"> <li>Cable sleeve</li> <li>Non-woven polyethylene</li> <li>For professional sealing of up to 6 cable feed-throughs</li> </ul>	4-11	230	230	
Gypsum boards		Width (mm)	Length (mm)	Thickness (mm)	Weight (approx kg/m²)
<b>Diamant 12.5mm (GKFI/DFH2IR)</b> 	<ul style="list-style-type: none"> <li>Used in all fields of interior works as cladding of premium drywall systems with enhanced requirements for sound insulation and fire protection</li> <li>Impregnated for reduced water absorption</li> <li>Colour of board liner: blue</li> <li>Non-combustible</li> <li>Long edges: Half-rounded tapered edges</li> <li>Front edges: cut edges</li> <li>GKFI according to DIN 18180</li> <li>DFH2IR according to EN 520</li> </ul>	1,250	2,000	12.5	9.4
			2,500		

Drywall screws		Width (mm)	Length (mm)	
<b>Diamantschraube XTN</b> 	<ul style="list-style-type: none"> <li>To fix Diamant boards (GKFI / DFH2IR) to metal and timber substructures</li> <li>Self-tapping thread</li> <li>Nail tip</li> <li>Metal thickness ≤0.7mm and timber constructions (except for XTN 3.9 x 23mm)</li> <li>Incl. one bit/package</li> </ul>	3.9	23	
			33	
			38	
			55	
<b>Diamantschraube XTB</b> 	<ul style="list-style-type: none"> <li>To fix Diamant boards (GKFI / DFH2IR) to metal substructures</li> <li>Self-tapping thread</li> <li>Drill tip</li> <li>Metal thickness: 0.7mm &lt; x ≤ 2.25mm</li> <li>Incl. one bit/package</li> </ul>	3.9	35	
			55	
Gypsum filler		Coverage (approx. kg/m²)	Storage life (approx month)	Weight (kg/bag)
<b>Uniflott</b> 	<ul style="list-style-type: none"> <li>Gypsum filler for hand filling joints of drywall systems</li> <li>Low drying shrinkage</li> <li>Very high crack resistance</li> <li>Quick drying and development of hardness</li> <li>Application in interiors for gypsum boards or composite boards with half-rounded edge (HRK) or half-rounded tapered edge (HRAK) without joint tape on paper liner covered edges with a metal stud frame</li> </ul>	0.5	9	5
				25

**Interior finishing**

From primers, renders, skim coatings and paint, Knauf offers a full range of surface finishes for every need – from standard to high-end Q4 specifications with minimal marks, traces or shading caused by shallow light angles. The end result will depend on the decorative finish required as well as the skills of the contractor.

Finishing plaster		Coverage (approx. kg/m²)	Storage life (approx month)	Weight (kg/bag)
<b>Super Finish</b> 	<ul style="list-style-type: none"> <li>Ready-to-use, all-purpose filler</li> <li>Suitable as joint finish (Q2), for full-surface filling (quality grades Q3 and Q4), as well as smoothing numerous substrates</li> </ul>	1.6	12	20





## PRODUCT HANDLING

### Boards



- › Always carry the boards upright, or use board rollers. Handle with fork lift or crane as palletted goods. Take care not to damage corners and edges when setting the boards down. Place boards down on their long edge before laying them flat.

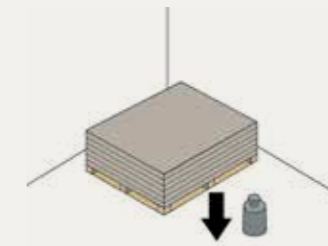

- › Ensure that the base is strong enough to support the boards.



- › Protect boards from moisture and weathering before they are installed. Boards which have become damp must be dried on both sides on a flat surface prior to fitting. Before installing, condition the boards to the ambient temperature and humidity.

### Profiles



- › Protect profiles from moisture and weathering before they are installed. Products should not be left permanently exposed to the elements.

### Powder materials



- › Store bags in a dry place and in original packaging.



- › Do not apply joint fillers, basecoat or finishing materials in temperatures less than +5°C.

### Health and safety

- › Avoid unnecessary dust on job site when using electrical saw. Keep sanding and other dust generation to a minimum. Maintain adequate ventilation and/or wear suitable protection.
- › Exercise care when using power tools and take all necessary precautions.
- › Follow instructions on packaging when applying system accessories.
- › When using powdered products, mix with water in well-ventilated conditions. Avoid contact with eyes and skin. In the event of contact with the eyes, irrigate with plenty of clean water immediately.
- › When handling insulation or cutting boards which contain glassfibre, wear suitable protection including face mask and gloves. Wear protective glasses when working overhead.
- › Follow national health and safety regulations at all times.

The product data sheets and material safety data sheets are available on our website [www.AQUAPANEL.com/downloads](http://www.AQUAPANEL.com/downloads).

### Insulation



- › Insulation materials are supplied enclosed in packaging which is designed for short term protection only. For longer term protection on site, the product should be stored either indoors, or under cover and off the ground. Products should not be left permanently exposed to the elements.



# INSTALLATION

## 1. Exterior Stud Frame

The steel framework must be designed according to the static requirements of the construction.

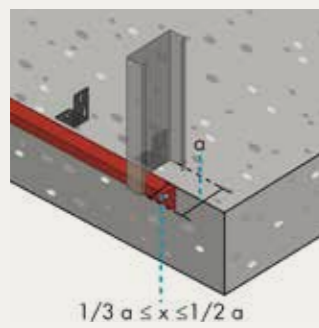
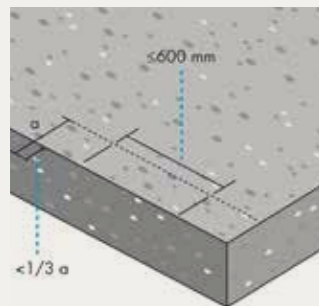

1.1 For an exterior wall, installed between floors, the maximum permissible cantilever of the studs is one third of their web height. If the cantilever exceeds this amount, the studs have to be supported by a steel angle, installed in front of the floors (even here an excess of a maximum cantilever of half of the web height is not allowed). In this system Knauf Exterior Wall Profiles with a web height of 150 mm are used, resulting in a maximum cantilever of 50 mm without the need of additional support.

1.2 For the correct alignment of the Knauf Exterior Wall, the vertical alignment of the slab edges of the skeleton construction is measured over all floors. To guarantee straight exterior walls, display the course of the walls on the floors, ceilings and columns before installing the profiles. It is recommended to use a chalk line, a cross-line laser or a rotating laser for these tasks.



1.3 Cut profiles up to 0.7 mm thickness to appropriate length using manual or electrical steel cutter or use an electrical circular saw with special metal blade.

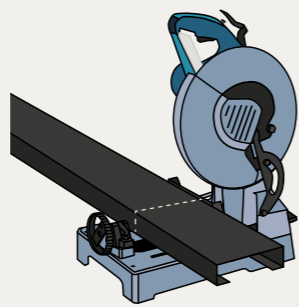

1.4 Metal thicknesses bigger than 0.7 mm cannot be cut by manual steel cutters. Electric separating tools need to be used. The tool has to be selected according to the coating system. This is especially important for lacquers and other organic coatings, which are damaged by the influence of temperature and flying sparks. The use of band saws, low speed chop saws ( $\leq 1500$  rpm) or special circular saws for cold cuts without flying sparks is highly recommended. Cut edges of corrosion-protected profiles with a nominal thickness bigger than 1.5 mm have to be treated with corrosion protection coating (e.g. Drystar-Korrosionsschutzlack C3/C5M).

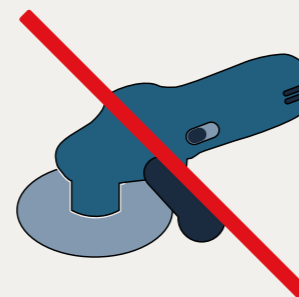

1.5 The use of separation methods causing sparks (e.g. angle grinders) destroy the corrosion protection of the profiles.



1.6 Use an appropriate drilling machine to drill holes into the reinforced concrete for the anchors.

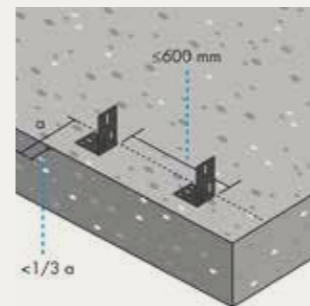

1.7 Fix Knauf Exterior Wall Angles 70x135/100 at ceilings and floors using approved anchoring means according to local building regulations (fire resistance) and static requirements (type and quantity of fasteners). The minimum distance of the fasteners to the floor end depends on the type of fastener used. Do not use plastic plugs due to fire regulations. Please respect the mandatory borehole diameters and depths for the screw anchors.

1.8 It is recommended to create the window/door openings first, before installing the studs of the undisturbed parts of the wall, because substantial time savings can be realized. Actually manufacturers can build windows in advance and transport them to the site, because they can work to precise plans and dimensions. So they are ready for immediate installation, while the rest of the studs are set up. The openings and its auxiliary structure have to be designed in accordance with building static requirements.

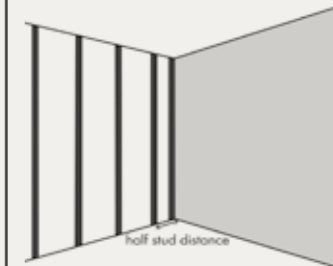
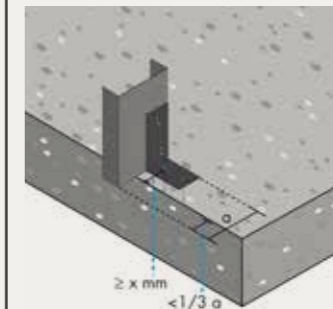
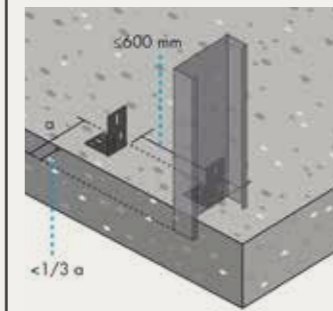
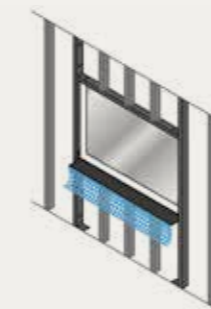

1.9 The distance between the vertical KEW Profiles is dependent on room height and static calculations (600 mm in maximum), the maximum distance between the first two studs next to other building elements such as walls and columns is half the distance calculated for the undisturbed wall. For instance 300 mm for walls with a normal stud spacing of 600 mm. Where KEW Profiles are directly connected to these building elements, use decoupling tape. For attaching the KEW Profiles to the KEW Steel Angles 70x135/100 use KEW Screws 4.8x20. In doing so, apply 3 screws at the bottom of the slotted holes in each of the KEW Steel Angles (at the floor and at the ceiling). This way possible tensions are avoided. The KEW Profiles are cut to length as usual in drywall construction: generally 10mm shorter than the distance between head and foot point.



## 2. Installing the Water Barrier

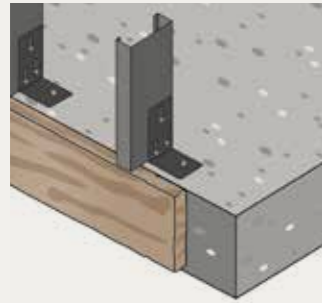

2.1 To prevent thermal bridges at the slab edges insulate the section in front of floors with a layer of glass wool insulation according to building physical requirements, before applying the water barrier. Note: The longer the cantilever, the thicker the insulation in front of the floors.

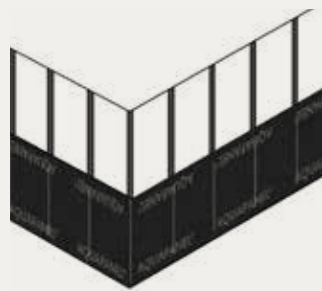

2.2 Before mounting AQUAPANEL® Cement Board Outdoor it is required to install the water and windproof AQUAPANEL® Water Barrier to protect the insulation. Start at the bottom of the wall and install the water barrier horizontally. Secure this foil temporarily by using double-sided adhesive tape, followed by the prompt installation of the boards. Therefore only install as much stretches of the foil, which you are able to cover by boards in one day. Overlap all horizontal and vertical joints of the water barrier at least 10 cm. The horizontal overlap is already marked on the product by two dashed lines. The overlaps themselves do not need to be masked by adhesives.

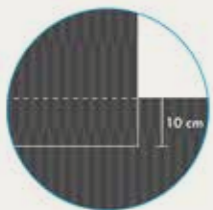

### › Option 1: Installing the water barrier onto window openings



2.3 Approximate to the wall opening from below. If the windows are not installed up to this moment, first cover the lintel area of the opening with a narrow strip of AQUAPANEL® Water Barrier and secure it with adhesive tape. Make sure that the installed strip overlaps at least 10 cm (see exemplary pattern with cut and bent edges).

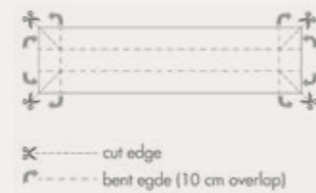

2.4 Cover the opening with one or more stretches of AQUAPANEL® Water Barrier just the same way as for the undisturbed areas of the wall. After that cut the foil horizontally at the lintel and the parapet and vertically in the middle of the window opening and open the resulting protrusions like window shutters to the outside (see picture).



2.5 Like the lintel, also the parapet of the window opening has to be covered with AQUAPANEL® Water Barrier. Therefore again cut a narrow strip of the foil and install it with adhesive tape. Also here the strip has to overlap at least 10 cm (see exemplary pattern with cut and bent edges above).

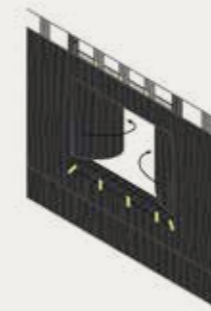

2.6 Fold the protrusions of the AQUAPANEL® Water Barrier inwards and secure it with tape so that it remains properly stretched at the vertical reveals.

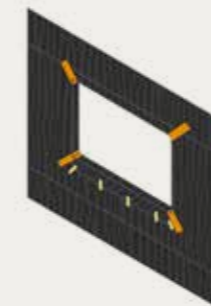

2.7 Reinforce window corners with an extra piece of tape, which is adhered directly in the window corners and to some extent pulled over the edges on the outside and inside surface of the wall (e.g. Knauf Insulation LDS Solitwin is particularly suited for this application).

### › Option 2: Installing the water barrier over preinstalled windows

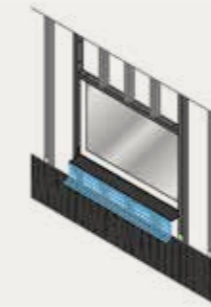

2.2 Approximate to the wall opening from below. If the windows are already installed before the application of the water barrier, just cover the window with one or more stretches of AQUAPANEL® Water Barrier the same way as for the undisturbed areas of the wall.



2.3 Cut out the area of the water barrier, which is covering the window, alongside the reveals, lintel and parapet.

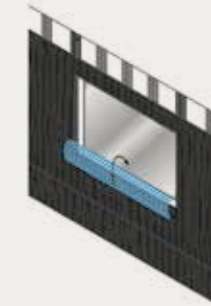

2.4 Fold up the reinforcing mesh underneath the windowsill and secure the water barrier at the parapet with an adhesive tape (e.g. Knauf Insulation LDS Solitop).

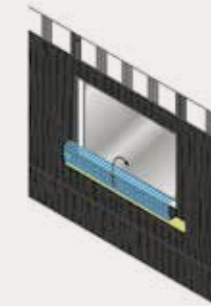

2.5 Finally secure the water barrier lengthwise along the edges of the reveals and the lintel.

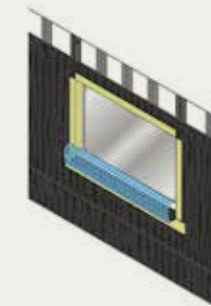
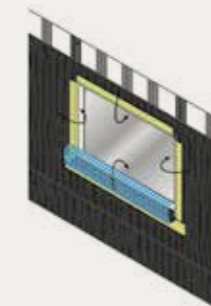

### 3. Exterior Board Installation

3.1 Mark the desired shape or opening on the board with pencil and ruler. Use a knife to score the cement or gypsum boards on one side along the line so that the mesh resp. thick paper is cut. Snap the scored edge and cut the mesh/paper on the rear side.



3.2 For sharp-edged cuts, for example, exterior edges, use a hand-held circular saw with a dust extractor or a pendulum jigsaw. Use of a carbide or diamond-tipped saw blade is recommended.

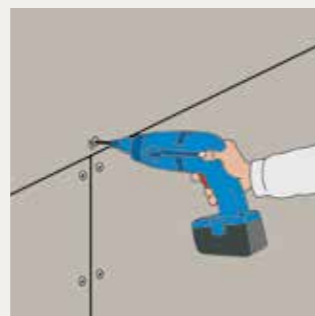
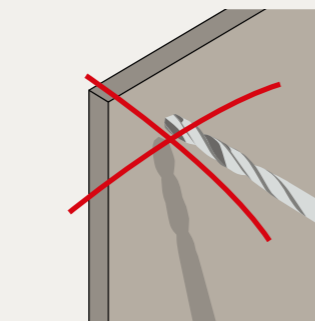
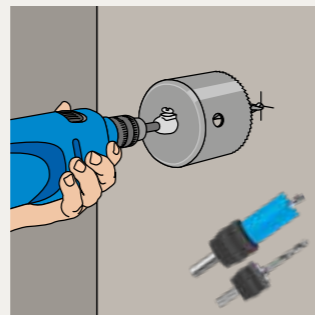
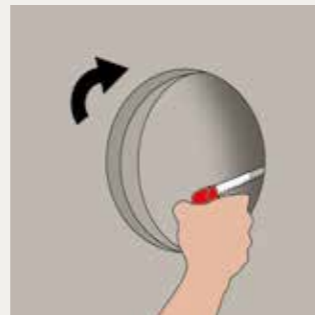

3.3 To make cut-outs for wiring and pipes, use a jigsaw or hole saw. The diameter of the opening should be approximately 10 mm greater than the diameter of the pipe. The remaining gap can be closed with a cuff, suitable sealant or sealing strip.

3.4 Generally, no pre-drilling of boards is required. However, pre-drilling of boards and profiles is needed if the material thickness of the profiles exceeds 2 mm (according to static requirements) or when blind rivets are used instead of screws.

3.5 To fasten the boards with screws use a screw gun with depth stop (comprising overturned sleeve and a stop sleeve). This ensures that all screws are countersunk in the same correct way. Fasten AQUAPANEL® Cement Board Outdoor to the stud frame with AQUAPANEL® Maxi Screws. First fasten the screws in the centre of the cement boards, then work towards the edges. During installation, make sure the cement boards fit closely to the substructure. Screws should not be overtightened.

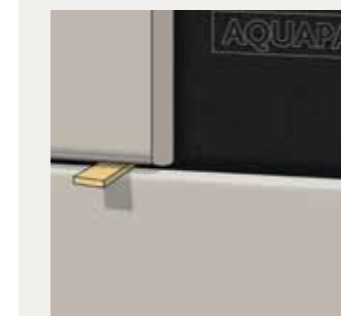
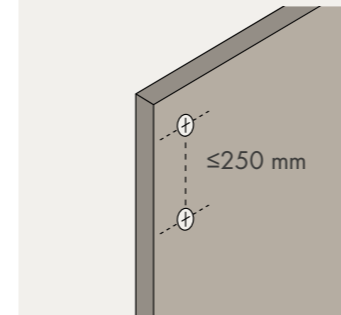
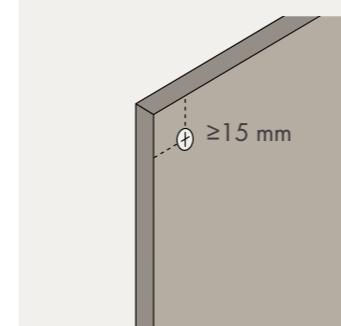

3.6 Follow rules of distances: the screw spacing must not exceed 250 mm and the spacing from the edge has to be at least 15 mm.

3.7 Apply AQUAPANEL® Cement Board Outdoor panels horizontally. Arrange front edge joints (vertical) on centre of profile flanges. Leave a gap of 3-5 mm between boards alongside the long and front edges (horizontal and vertical) using a suitable spacer. Front edge joints (vertical) must be staggered by at least one stud spacing.

**Note:** Hairline cracks on the surface of the AQUAPANEL® Cement Board Outdoor are no indications of loss of strength or function, as long as embedded glass fibre mesh is intact.

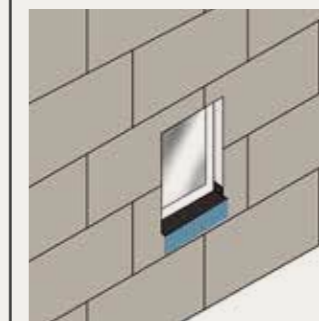
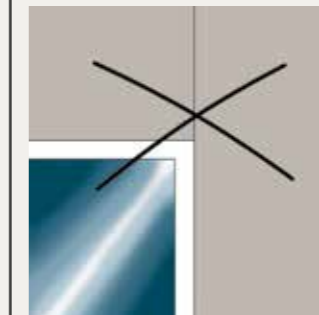
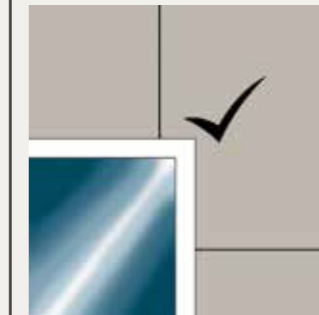

3.8 Take the boards up to the parapet, reveals and parapet of the window or the door. There must be no continuous joints as these could lead to cracks and leaks. The spacing between the board joints and the imaginary extensions (horizontal and vertical) of the window frames has to be at least 150 mm.

**Note:** If the windows are already installed, just make sure to fold up the reinforcing mesh underneath the windowsill before fixing AQUAPANEL® Cement Board Outdoor beneath the parapet.



#### 4. Joint Treatment



4.1 Immediately after fixing the boards, protect the wall from weathering by filling all the joints with AQUAPANEL® Joint Filler – grey. Use an agitator to mix the joint filler. A tool with 600 rpm is recommended.

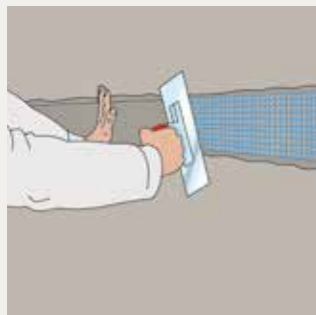
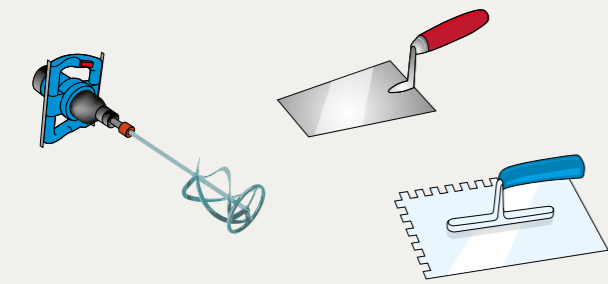

4.2 Right after that embed AQUAPANEL® Tape (10 cm) centred alongside all joints.

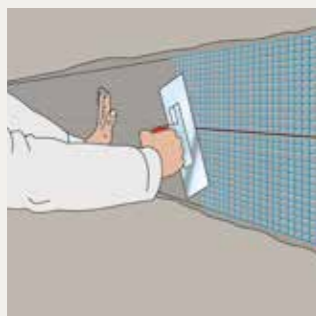

4.3 If later only one coat of paint is to be applied onto AQUAPANEL® Exterior Basecoat or AQUAPANEL® Exterior Basecoat – white, use AQUAPANEL® Exterior Reinforcing Tape which has a width of 20 cm.



4.4 Finally cover the screw heads with AQUAPANEL® Joint Filler – grey.

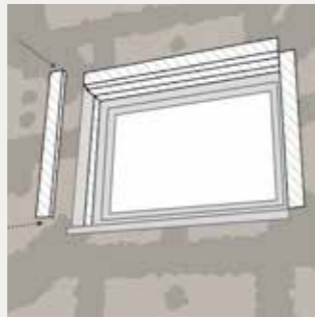

4.5 Mount appropriate PVC-plaster profiles at the corners and edges of the windows to protect them. Embed it in AQUAPANEL® Joint Filler – grey.

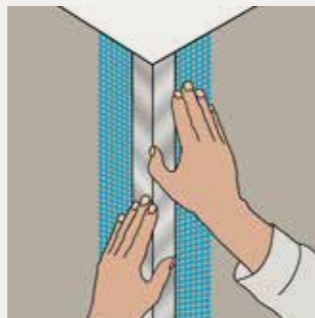

4.6 Outside corners are reinforced by applying a PVC-corner profile with AQUAPANEL® Joint Filler – grey.

**Note:** In this state the building envelope is closed. The wall surface may now be freely exposed to the weather for up to six months, before applying render or other finishings. As a result, interior works (including screeding and the installation of stud frames, vapour barrier, lining and insulation) can progress. Before the exterior finishing, the boards only have to be cleaned and dried off.

#### 5. External Thermal Insulation Composite System

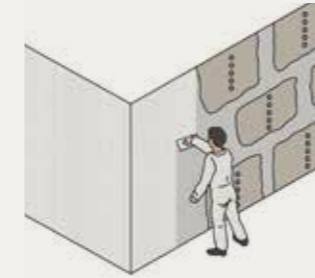

5.1 AQUAPANEL® Cement Board Outdoor can be rendered with adhesive mortar (e.g. Knauf Pastol Dry, depending on availability), when an external thermal insulation composite system (ETICS) is applied. Please choose an appropriate mortar consistent with the respective ETIC system. The adhesive mortar is applied by hand using a trowel (use an agitator to mix) or by machine (machine recommendation: mixing pump PFT G4, rotor/stator D3-4, half power, water requirement 130 l/h).

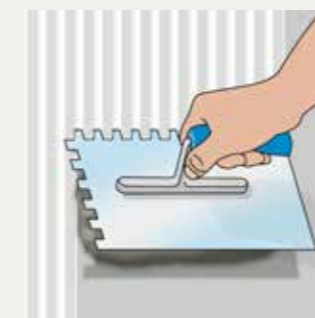

5.2 The bonding of the insulation boards (e.g. MW Volamit) needs to be made over the full surface with a notched trowel with 8 x 8 mm notches either on the insulation boards themselves or on the AQUAPANEL® Cement Board Outdoor. Immediately push, float and press the Insulation boards into the mortar bed. Before continuing with the next steps, allow a curing time of at least 3 days (with high humidity and low temperatures the drying time can significantly increase).

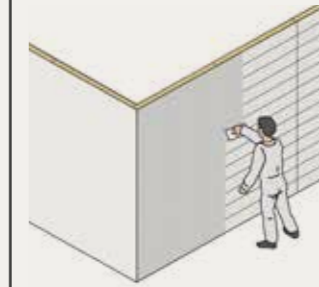
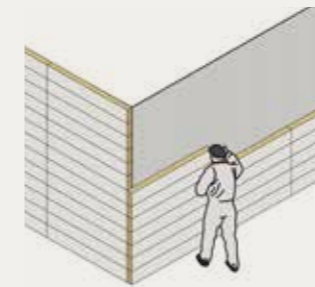

5.3 On top of the insulation boards, the basecoat (e.g. Knauf SM700 Pro) is applied by hand using a trowel (use an agitator to mix) or by machine (machine recommendation: mixing pump PFT G4).

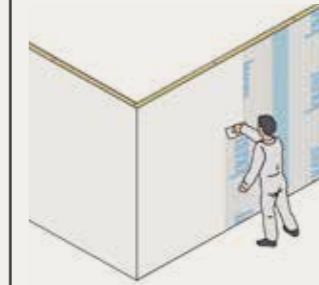

5.4 Gently embed/place reinforcement mesh (e.g. Knauf Armiergewebe 4x4) on the entire surface with at least a joint overlap of 100 mm “fresh-in-fresh” in the upper third of the basecoat layer. The reinforcement mesh should be fully covered with basecoat (SM700 Pro). Thickness of the basecoat layer on Knauf WARM WALL Plus systems is 5 - 10 mm.

**Note:** A drying time of min. 1 day per mm basecoat thickness\* is required prior to application of mineral-based render finishes. Paste-like finishing coats may not be applied before SM700 Pro is fully dry, minimum drying time is 10 days\*. In addition, we strongly recommend application of a Quarzgrund primer before pastelike finishing coats are applied. The stated drying times may be significantly longer in case of cool or wet weather.

\*All time specifications given here are depending on climate conditions.



## 6. Insulation of the Exterior Stud Frame



6.1 At first the exterior stud frame has to be insulated. Use the right product for the job depending on whether thermal insulation, acoustic insulation or fire protection is required. Insulation materials are easy to handle and install, being lightweight and easily cut to size. Where necessary, use an appropriate knife on flat surface to cut.



6.2 To minimise thermal bridges insulation should fill the complete stud spaces. Do not use small pieces. Do not lay electrical and pipe installations inside the single stud exterior wall.

## 7. Interior Lining



7.1 After filling the stud frame completely with insulation material, install the first layer of gypsum boards (GKFI). Place the panel edges in the middle of the stud flanges.



7.2 Fix the gypsum boards (GKFI) with appropriate screws (e.g. Knauf Diamantschrauben XTN 3.9x23) to the substructure. Penetration of the metal substructure has to be at least 10 mm. Follow rules of distances: the screw spacing must not exceed 750 mm (board width: 1250 mm in a vertical board positioning) resp. 600 mm (board width: 625 mm in horizontal board positioning) and the spacing from the edge has to be at least 10 mm (half-rounded tapered edges) resp. 15 mm (cut edges). Fill joints fully (e.g. standard gypsum board application with half-rounded tapered edges). Use trowel to fill joints with suitable joint filler (e.g. Uniflott).

**Note:** At this stage protection against falling is ensured and the scaffold on the exterior can be dismantled.

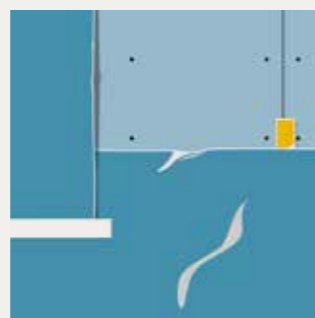

7.3 Install the Knauf Insulation LDS 10 Silk vapour barrier over the entire surface. The vapour barrier must overlap where more than one sheet is placed. Overlaps, window connections and pipe and service penetrations have to be sealed with appropriate adhesion tapes (e.g. Knauf Insulation LDS Soliplan, Solitwin or Solifit S) in order to obtain optimum air tightness. one another.

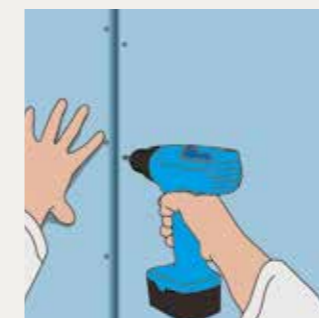
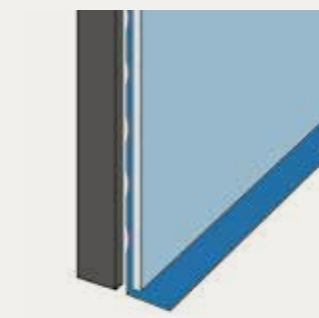
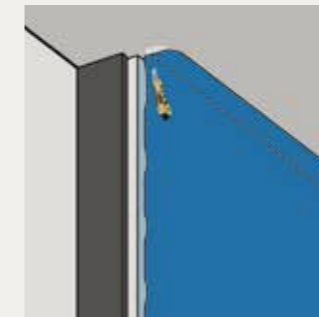
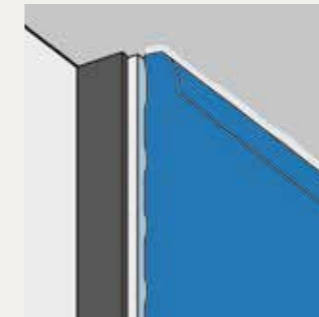
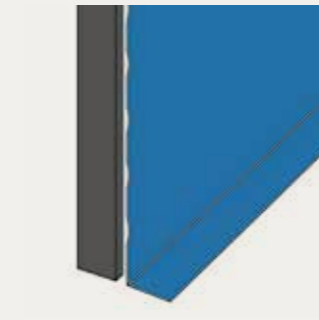

7.4 At the low and at the head end, let the vapour barrier project. Fill the gap between vapour barrier and ceiling with an appropriate adhesive (e.g. Knauf Insulation LDS Solimur) and cut of the residual overhang with a cutter knife. The overhang on the floor does not need to be treated, as it will be covered with flooring later.

7.5 Mount gypsum boards (GKFI) in front of the vapour barrier. Work in staggered method; stagger at least one stud space. To fix the boards to the substructure use an appropriate drywall screw (e.g. Knauf Diamantschraube XTN 3.9x38). Penetration of the metal substructure has to be at least 10 mm. The screw spacing must not exceed 250 mm (board width: 1250 mm in vertical board positioning) resp. 200 mm (board width: 625 mm in horizontal board positioning) and the spacing from the edge has to be at least 10 mm (half-rounded tapered edges) resp. 15 mm (cut edges).



7.6 Fill joints fully (e.g. standard gypsum board application with half-rounded tapered edges). Use trowel to fill joints with suitable joint filler (e.g. Uniflott).



7.7 Run the trowel progressively down the joint applying sufficient pressure to squeeze out entrapped air. Allow the joint filler to set for approx. 1 hour. If required, sand lightly to remove any high spots. Remove surface dust.

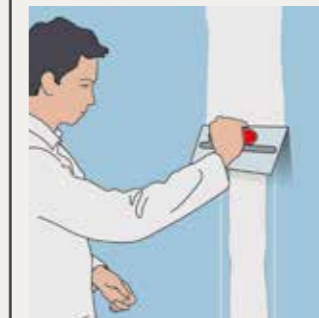

7.8 Apply an additional thin layer of joint filler and remove any surplus filler. Create a smooth and levelled transition to the board surface with Trowel or Wide Spatula. Feather out application beyond the joints – approximately 100 to 200 mm.



7.9 Allow the joint filler to set for approx. 1 hour. If required, sand lightly to remove any high spots. Remove surface dust.

## 8. Interior Finishing

For detailed information about interior finishing options, please contact your local Knauf organisation.

## MATERIAL CONSUMPTION & ERECTION TIME

Product Group	Materials (from the inside to the outside)	Thickness (mm)	Weight per m <sup>2</sup> (kg)	Material consumption per m <sup>2</sup>	Unit	Installation time per m <sup>2</sup> (min)
Stud framework (600 mm stud spacing)	Knauf Diamant (GKFI/DFH2IR) or similar	12.50	12.80	1	m <sup>2</sup>	47
	Knauf Diamantschraube XTN 3,9 x 23 mm	-	-	7	pcs.	
	Knauf Diamantschraube XTN 3,9 x 38 mm	-	-	15	pcs.	
	Knauf Uniflott or similar	-	0.40	0.4	kg	
	Knauf Trennfix or similar	-	-	0.9	m	
	Knauf Insulation LDS 10 silk or similar	-	-	1.1	m <sup>2</sup>	
	Knauf Insulation LDS adhesive tape	-	-	1	pcs.	
	Knauf Diamant (GKFI/DFH2IR) or similar	12.50	12.80	1	m <sup>2</sup>	
	KEW Profile 150 (minimum corrosion protection C3)	-	3.40	2	linear m	
	Anchoring means (to be provided on site)	-	-	3	pcs.	
	KEW Steel Angle 70x135/100 (min. corrosion protection C3)	-	-	1.5	pcs.	
	KEW Screw 4.8 x 20 (rustproofed)	-	-	4.5	pcs.	
Insulation board according to local needs	150.00	2.70	1	m <sup>2</sup>		
Water barrier / windproofing	AQUAPANEL® Water Barrier	-	-	1.1	m <sup>2</sup>	2
	Adhesive tape	-	-	1	pcs.	
Exterior lining	AQUAPANEL® Cement Board Outdoor	12.50	16.00	1	m <sup>2</sup>	15
	AQUAPANEL® Maxi Screw SN25	-	-	15	pcs.	
	AQUAPANEL® Joint Tape (10cm)	-	-	2.1	linear m	
	AQUAPANEL® Joint Filler - grey	-	0.70	0.7	kg	
External thermal insulation composite system (ETICS)	Adhesive Mortar Knauf Pastol Dry	2.00	2.80	2.8	kg	40
	MW Volamit O40	80.00	6.40	1	m <sup>2</sup>	
	Knauf SM700 Pro	5.00	7.00	7	kg	
	Knauf Armiergewebe 4x4 mm	-	-	1.1	m <sup>2</sup>	
Sum		274.50	72.06			104





## BENEFIT FROM THE VALUABLE SERVICES FROM AQUAPANEL®



AQUAPANEL® WEBSITE

Discover a world of online resources and support available 24/7 to help you understand and communicate the full scope of the AQUAPANEL® family. Find and download in-depth technical documents, films and the latest materials, always up to date.

› [www.aquapanel.com](http://www.aquapanel.com)



INTERNATIONAL TRAINING CENTRE

Stay in the loop and keep your knowledge at the cutting edge with professional, practical seminars from the AQUAPANEL® International Training Centre. With courses designed to give you and your people fresh insights and understanding you get a unique advantage. For more information, please contact your local AQUAPANEL® partner or email us:

› [aquapanel.info@knauf.com](mailto:aquapanel.info@knauf.com)



YOUTUBE CHANNEL

See AQUAPANEL® in action. Our YouTube channel features product introductions and how-to videos on everything from installation to finishing options and curved wall constructions. It's all available any time – and we'll be regularly updating the channel with our latest videos, making it the first place to go for new AQUAPANEL® content.

› [www.youtube.com](http://www.youtube.com)  
Search: Knauf Aquapanel

All technical changes reserved. Only the current printed instructions are valid. Our warranty is expressly limited to our products in flawless condition. The constructional and structural properties and characteristic building physics of Knauf systems can solely be ensured with the exclusive use of Knauf system components, or other products expressly recommended by Knauf. All application quantities and delivery amounts are based on empirical data that are not easily transferable to other deviating areas. All rights reserved. All amendments, reprints and photocopies, including those of excerpts, require the express permission of Knauf Aquapanel GmbH & Co. KG, Zur Helle 11, 58638 Iserlohn, Germany. AQUAPANEL® is a registered trademark.